

can-am®



3-Wheel Vehicles Product Spec Book

2025

Vehicle Specifications, Accessories, Parts and Maintenance, and Apparel

TABLE OF CONTENTS

VEHICLE SPECIFICATIONS

BRP Limited Warranty	5
Ryker®	6
Ryker Sport	8
Ryker Rally	10
Spyder® F3-S	12
Spyder F3-T	14
Spyder F3 Limited	16
Spyder F3 Limited Special Series	18
Spyder RT Limited	20
Spyder RT Sea-to-Sky	22
Canyon	24
Canyon XT	26
Canyon Redrock	28
Comparative chart	30

ACCESSORIES

Panels and Hoods	36
Handlebars	37
Brake and Shifter Linkages	38
Seats and Backrests	38
Windshields and Wind Protection	44
Cargo and Storage	47
Footboards	58
Idler Pulley	58
Lights and Electrical Accessories	59
Wheels and Fenders	63
Shocks	64
Silencers	64
Custom Accessories	65
Ride Protection	68
Covers	71

PARTS AND MAINTENANCE

Genuine Can-Am Parts	76
XPS Engine Oils	77
XPS Maintenance Products	78

APPAREL

Sizing Chart	80
Helmets	82
Communication Systems	84
Riding Gear	89
CE and SAS-TEC	92
Gloves	93
Rain Gear	96
Sportswear	97
Caps and Neckwear	101
Bags and Accessories	102

CANAMONROAD.COM

©2024 Bombardier Recreational Products Inc. (BRP). All rights reserved. ®, TM and the BRP logo are trademarks of BRP or its affiliates. In the USA, products are distributed by BRP US Inc. †All other trademarks are the property of their respective owners. BRP reserves the right to discontinue or change specifications, prices, designs, features, models or equipment without incurring obligation. Some models shown may include optional equipment. Products performance may vary depending on external factors. Read the operator's guide and safety instructions. Observe applicable laws and regulations. Always wear appropriate protective clothing, including a helmet. Riding and alcohol/drugs don't mix. Always ride responsibly and safely. Respect the environment and natural areas. Always stay on permitted and designated routes. Do not use the vehicle on any other terrain. Always follow local laws and regulations. Respect the environment and natural areas. Always stay on permitted and designated routes. Do not use the vehicle on any other terrain. Always follow local laws and regulations. See your authorized BRP dealer for details and visit <https://can-am.brp.com/>.



VEHICLE SPECIFICATIONS

VEHICLE SPECIFICATIONS

WARRANTY

BRP Limited Warranty	5
----------------------	---

RYKER

Ryker®	6
Ryker Sport	8
Ryker Rally	10

SPYDER

Spyder® F3-S	12
Spyder F3-T	14
Spyder F3 Limited	16
Spyder F3 Limited Special Series	18
Spyder RT Limited	20
Spyder RT Sea-to-Sky	22

CANYON

Canyon	24
Canyon XT	26
Canyon Redrock	28

COMPARATIVE CHART

Comparative chart	30
-------------------	----



IF WE SELL IT, WE STAND BY IT.

**BRP Limited Warranty*
for new riding parts,
accessories
and riding gear.**

1-YEAR LIMITED WARRANTY**

Genuine BRP Parts and Accessories
installed by you or your authorized BRP dealer

**Aftermarket Products sold through BRP
Riding Gear**

4-YEAR LIMITED WARRANTY**

Helmets

GET ALL THE DETAILS FROM YOUR CAN-AM 3-WHEEL DEALER

*Purchased at an authorized BRP dealership/distributor or on a BRP-authorized online store. Other exclusions may apply; see complete limited warranty or contact your Can-Am 3-wheel authorized dealer.

**Unless otherwise stipulated or required by law.

This limited warranty does not apply to factory-installed accessories.
This limited warranty does not apply to Evinrude parts and accessories.

2025 RYKER

VEHICLE SPECIFICATIONS



WHAT'S NEW

- XPS Ride tires

PACKAGE HIGHLIGHTS

- Priced to excite
- Designed for fun
- Easy to ride
- 100,000 ways to make it your own

SHOWN WITH INTENSE BLACK PANELS

SPORT MODE** / **U-FIT** / **ECO**

	Rotax® 600 ACE™	Rotax® 900 ACE™
ENGINE		
Type	Rotax® 600 ACE™ in-line 2 cylinders, liquid-cooled with electronic fuel injection and electronic throttle control	Rotax® 900 ACE™ in-line 3 cylinders, liquid-cooled with electronic fuel injection and electronic throttle control
Bore & stroke	74 x 69.7 mm (2.9 x 2.7 in.)	
Power	50 hp (37.3 kW) @ 7300 RPM	82 hp (61.1 kW) @ 8000 RPM
Torque	36.7 lb-ft (49.7 Nm) @ 6000 RPM	58.3 lb-ft (79.1 Nm) @ 6500 RPM
CO ₂ emissions	127 g/km	143 g/km
Fuel consumption	5.4 l/100 km (43.6 mpg)	6.08 l/100 km (38.7 mpg)
TRANSMISSION		
Type	Automatic (CVT) with reverse function	
CHASSIS		
Front suspension	Double wishbone	
Front shock type/travel	SACHS ¹ Twin-tube coil-over shocks / 136 mm (5.35 in.)	
Rear suspension	Multi-link - mono swing arm	
Rear shock type/travel	SACHS ¹ Twin-tube coil-over shocks with preload adjustment / 145 mm. (5.71 in.)	
Electronic brake distribution system	Foot-operated, hydraulic 3-wheel brake	
Front brakes	270 mm discs with Nissin 2-piston floating calipers	
Rear brake	220 mm disc, 1-piston floating caliper	
Parking brake	Park lock	
Front tires	XPS Ride - 145/60 R16 MC 66T	
Rear tire	XPS Ride - 205/45 R16 MC 77T	
Aluminum front rims	10-spoke, Platinum silver, 406 x 114 mm. (16 x 4.5 in.)	
Aluminum rear rim	10-spoke, Platinum silver, 406 x 165 mm. (16 x 6.5 in.)	
CAPACITY		
Rider capacity	1	
Maximum vehicle load	204 kg (449.7 lb)	
Storage capacity	7 L. (1.85 gal)	
Fuel capacity	20 L. (5.28 gal)	
Fuel type	Premium unleaded	

	Rotax® 600 ACE™	Rotax® 900 ACE™
DIMENSIONS		
L x W x H	2,352 x 1,522 x 1,063 mm (92.6 x 59.9 x 41.9 in.)	2,352 x 1,522 x 1,060 mm (92.6 x 59.9 x 41.7 in.)
Wheelbase	1,709 mm (67.3 in.)	
Seat height	599 mm (23.6 in.)	597 mm (23.5 in.)
Ground clearance	97 mm (3.8 in.)	
Dry weight	270 kg (594 lb)	280 kg (616 lb)

INSTRUMENTATION		
Type	11.4 cm (4.5 in.) digital display	
Main functions	Speedometer, tachometer, odometer, trips, distance to empty, engine lights, fuel gauge, clock	Speedometer, tachometer, odometer, trips, distance to empty, engine lights, fuel gauge, clock, ECO mode and Sport mode

SAFETY & SECURITY	
SCS	Stability Control System
TCS	Traction Control System
ABS	Anti-lock Braking System
Anti-theft system	Digitally Encoded Security System (D.E.S.S.™)
HHC	Hill Hold Control

COVERAGE	
Factory warranty	2-year BRP Limited Warranty
Extended service terms	2-year roadside assistance provided by Allianz Assistance, world leader in Automotive and Travel assistance, on behalf of BRP*

FEATURES		
	2 halogen headlamps (55 W) Front fenders with integrated LED lights Dual USB port Glove box (1.8 gal / 6.8 l.) Full rear fender Adaptive foam waterproof seat	2 halogen headlamps (55 W) Front fenders with integrated LED lights Dual USB port Glove box (1.8 gal / 6.8 l.) Full rear fender Adaptive foam waterproof seat Sport mode

*Available on vehicles registered by an authorized BRP dealer in the United Kingdom, Ireland, France, Netherlands, Belgium, Luxembourg, Germany, Austria, Switzerland, Italy, Spain or Portugal.

**Only on Rotax 900 ACE Engine option



*In the UK, you can ride Can-Am 3-Wheel vehicles with a car licence (B) from the age of 21 years old. In Norway, Finland and Sweden, you can ride Can-Am 3-Wheel vehicles with a car licence (B) under certain conditions. More details on A and B licence requirements at canamonroad.com/licence. For all other countries, please ask your local authority.

CLASSIC SERIES¹



Intense Black Adrenaline Red Yellow Shock

EPIC SERIES

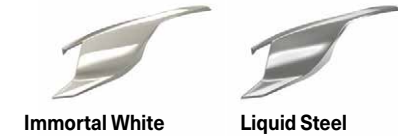

Immortal White Liquid Steel

EXCLUSIVE SERIES²



Racer Red Liquid Titanium Heritage Yellow Mint Freeze

NEW PANELS



Urban Blue Atlantis Gold Cyber Orange Moka Plaid

Feature highlights



AUTOMATIC TRANSMISSION (CVT)

No need to worry about changing gears as your continuously variable transmission will find the perfect combination of performance and fuel efficiency for you.



ENGINE OPTIONS

The 2-cylinder Rotax 600 ACE is the ultimate in accessible performance, while the 3-cylinder Rotax 900 ACE is the power and excitement standard of choice!



DRIVESHAFT

Highly durable and robust driveshaft technology will help you enjoy a smooth ride all along the way. No need for further adjustment, alignment or maintenance.



UFIT

Tool-free adjustment of handlebars and footrests to suit the driver and provide a personalized and comfortable driving experience.



VSS SYSTEM

Vehicle Stability System that uses a variety of technologies, including SCS/ABS/TCS, to monitor the vehicle and keep the rider confident on the road.



CUSTOMIZATION

The Can-Am Ryker was engineered to be almost infinitely customizable with 1 or 2-up options! Mere moments are all it takes to give it a transformation.

¹Choice of one set of Classic Panels included upon vehicle purchase. ²Exclusive Panel Kits are available in limited quantities.
2025

2025 RYKER SPORT



WHAT'S NEW

- XPS Ride tires

PACKAGE HIGHLIGHTS

- Exciting & thrilling ride
- Designed for fun
- Bold sport styling
- Added comfort and convenience

SHOWN WITH INTENSE BLACK PANELS



Rotax® 900 ACE™

ENGINE

Type	Rotax® 900 ACE™ in-line 3 cylinders, liquid-cooled with electronic fuel injection and electronic throttle control
Bore & stroke	74 x 69.7 mm (2,9 x 2,7 in.)
Power	82 hp (61.1 kW) @ 8000 RPM
Torque	58.3 lb-ft (79.1 Nm) @ 6500 RPM
CO ₂ emissions	143 g/km
Fuel consumption	6.08 l/100 km (38.7 mpg)

TRANSMISSION

Type	Automatic (CVT) with reverse function
------	---------------------------------------

CHASSIS

Front suspension	Double wishbone
Front shock type/travel	KYB® HPG with preload adjustment 161 mm (6.34 in.)
Rear suspension	Multi-link - mono swing arm
Rear shock type/travel	KYB HPG with remote reservoir 4-positions compression adjustable damping and preload adjustment / 169 mm. (6.65 in.)
Electronic brake distribution system	Foot-operated, hydraulic 3-wheel brake
Front brakes	270 mm discs with Nissin 2-piston floating calipers
Rear brake	220 mm disc, 1-piston floating caliper
Parking brake	Park lock
Front tires	XPS Ride - 145/60 R16 MC 66T
Rear tire	XPS Ride - 205/45 R16 MC 77T
Aluminum front rims	5-spoke, Deep Black, machined and tinted, 406 x 114 mm (16 x 4.5 in.)
Aluminum rear rim	5-spoke, Deep Black, machined and tinted, 406 x 165 mm. (16 x 6.5 in.)

CAPACITY

Rider capacity	1
Maximum vehicle load	199 kg (438.7 lb)
Storage capacity	7 L. (1.85 gal)
Fuel capacity	20 L. (5.28 gal)
Fuel type	Premium unleaded

Rotax® 900 ACE™

DIMENSIONS

L x W x H	2,352 x 1,522 x 1,073 mm (92.6 x 59.9 x 42.2 in.)
Wheelbase	1,709 mm (67.3 in.)
Seat height	629 mm (24,7 in.)
Ground clearance	101 mm (4.0 in.)
Dry weight	291 kg (642 lb)

INSTRUMENTATION

Type	11,4 cm (4.5 in.) digital display
Main functions	Speedometer, tachometer, odometer, trips, distance to empty, engine lights, fuel gauge, clock, ECO mode and Sport mode.

SAFETY & SECURITY

SCS	Stability Control System
TCS	Traction Control System
ABS	Anti-lock Braking System
Anti-theft system	Digitally Encoded Security System (D.E.S.S.™)
HHC	Hill Hold Control

COVERAGE

Factory warranty	2-year BRP Limited Warranty
Extended service terms	2-year roadside assistance provided by Allianz Assistance, world leader in Automotive and Travel assistance, on behalf of BRP*

FEATURES

- 2 halogen headlamps (55 W)
- Front fenders with integrated LED lights
- Dual USB port
- Glove box (1.8 gal / 6.8 l.)
- Full rear fender
- MAX Mount Structure
- Cruise control
- Sport mode
- Sport comfort seat
- Sport style trims and finishes

*Available on vehicles registered by an authorized BRP dealer in the United Kingdom, Ireland, France, Netherlands, Belgium, Luxembourg, Germany, Austria, Switzerland, Italy, Spain or Portugal.



*In the UK, you can ride Can-Am 3-Wheel vehicles with a car licence (B) from the age of 21 years old. In Norway, Finland and Sweden, you can ride Can-Am 3-Wheel vehicles with a car licence (B) under certain conditions. More details on A and B licence requirements at canamonroad.com/licence. For all other countries, please ask your local authority.

CLASSIC SERIES¹



Intense Black Adrenaline Red Yellow Shock

EPIC SERIES

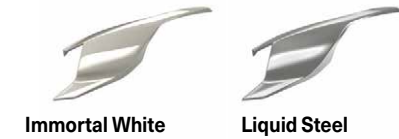

Immortal White Liquid Steel

EXCLUSIVE SERIES²

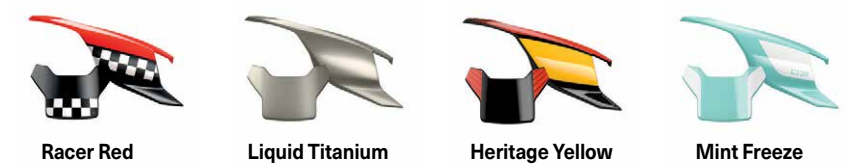

Racer Red Liquid Titanium Heritage Yellow Mint Freeze

NEW PANELS



Urban Blue Atlantis Gold Cyber Orange Moka Plaid

Feature highlights



CRUISE CONTROL

No need to keep the throttle at all times, the cruise control can be switched on to maintain a selected constant speed.



KYB[†] HPG SHOCKS

KYB HPG shocks with remote adjusters on the rear for different riding experiences.



MAX MOUNT STRUCTURE

Makes the unit 1+1 ready. It also increases the carrying capacity for different storage options.



SPORT MODE

Allows you to have more fun on paved roads. Sport mode loosens the traction control of the rear wheel enabling you to perform controlled drifts



DRIVESHAFT

Highly durable and robust driveshaft technology will help you enjoy a smooth ride all along the way. No need for further adjustment, alignment or maintenance.



SPORT STYLE TRIMS AND FINISHES

Modern design with a sleeker look for sport style enthusiasts.

¹Choice of one set of Classic Panels included upon vehicle purchase. ²Exclusive Panel Kits are available in limited quantities.

2025 RYKER RALLY



WHAT'S NEW

- XPS Rally tires

PACKAGE HIGHLIGHTS

- Go off the beaten path
- Designed for fun with access to new playgrounds
- Unique rugged style
- Authentic all-road rally experience

SHOWN WITH INTENSE BLACK PANELS



Rotax® 900 ACE™

ENGINE

Type	Rotax® 900 ACE™ in-line 3 cylinders, liquid-cooled with electronic fuel injection and electronic throttle control
Bore & stroke	74 x 69.7 mm (2.9 x 2.7 in.)
Power	82 hp (61.1 kW) @ 8000 RPM
Torque	58.3 lb-ft (79.1 Nm) @ 6500 RPM
CO ₂ emissions	143 g/km
Fuel consumption	6.08 l/100 km (38.7 mpg)

TRANSMISSION

Type	Automatic (CVT) with reverse function
------	---------------------------------------

CHASSIS

Front suspension	Double wishbone
Front shock type/travel	KYB HPG with remote reservoir 4-positions compression adjustable damping and preload adjustment / 185 mm (7.28 in.)
Rear suspension	Multi-link - mono swing arm
Rear shock type/travel	KYB HPG with remote reservoir 4-positions compression adjustable damping and preload adjustment / 179 mm. (7.05 in.)
Electronic brake distribution system	Foot-operated, hydraulic 3-wheel brake
Front brakes	270 mm discs with Nissin 2-piston floating calipers
Rear brake	220 mm disc, 1-piston floating caliper
Parking brake	Park lock
Front tires	XPS Rally - 145/60 R16 MC 66T
Rear tire	XPS Rally - 205/55 R15 MC 81T
Aluminum front rims	15-spoke, Hyper Silver, 406 x 114 mm. (16 x 4.5 in.)
Aluminum rear rim	15-spoke, Hyper Silver, 381 x 165 mm. (15 x 6.5 in.)

CAPACITY

Rider capacity	1
Maximum vehicle load	187 kg (412.2 lb)
Storage capacity	7 L. (1.85 gal)
Fuel capacity	20 L. (5.28 gal)
Fuel type	Premium unleaded

Rotax® 900 ACE™

DIMENSIONS

L x W x H	2,532 x 1,522 x 1,090 mm (92.6 X 59.9 X 42.9 in.)
Wheelbase	1,709 mm (67.3 in.)
Seat height	676 mm (26.6 in.)
Ground clearance	122 mm (4.8 in.)
Dry weight	303 kg (668 lb)

INSTRUMENTATION

Type	11.4 cm (4.5 in.) digital display
Main functions	Speedometer, tachometer, odometer, trips, distance to empty, engine lights, fuel gauge, clock, ECO mode and Rally mode

SAFETY & SECURITY

SCS	Stability Control System
TCS	Traction Control System
ABS	Anti-lock Braking System
Anti-theft system	Digitally Encoded Security System (D.E.S.S.™)
HHC	Hill Hold Control

COVERAGE

Factory warranty	2-year BRP Limited Warranty
Extended service terms	2-year roadside assistance provided by Allianz Assistance, world leader in Automotive and Travel assistance, on behalf of BRP*

FEATURES

2 halogen headlamps (55 W)	Akrapovič exhaust
Front fenders with integrated LED lights	Rally handlebar
Dual USB port	Adjustable large anti-slip foot pegs
Glove box (1.8 gal / 6.8 l.)	Front suspension protection
Rally mud flaps	Skid plate
MAX Mount Structure	Air intake with pre-filter
Cruise control	Front grille protection
Rally mode	Reinforced rims
Rally comfort seat	
Hand guards	

*Available on vehicles registered by an authorized BRP dealer in the United Kingdom, Ireland, France, Netherlands, Belgium, Luxembourg, Germany, Austria, Switzerland, Italy, Spain or Portugal.



*In the UK, you can ride Can-Am 3-Wheel vehicles with a car licence (B) from the age of 21 years old. In Norway, Finland and Sweden, you can ride Can-Am 3-Wheel vehicles with a car licence (B) under certain conditions. More details on A and B licence requirements at canamonroad.com/licence. For all other countries, please ask your local authority.

CLASSIC SERIES¹



Intense Black Adrenaline Red Yellow Shock

EPIC SERIES

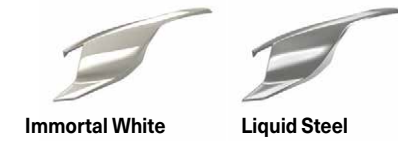

Immortal White Liquid Steel

EXCLUSIVE SERIES²

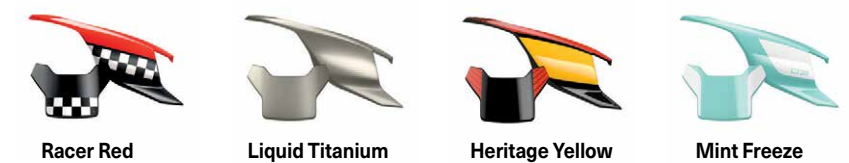

Racer Red Liquid Titanium Heritage Yellow Mint Freeze

NEW PANELS



Urban Blue Atlantis Gold Cyber Orange Moka Plaid

Feature highlights



AKRAPOVIČ EXHAUST
Unique sound signature and high-end exhaust.



FULL KYB[®] HPG SHOCKS
Front and rear KYB HPG shocks with remote adjusters and 1 inch of extra suspension travel to optimize your ride and improve comfort.



MAX MOUNT STRUCTURE
Makes the unit 1+1 ready. It also increases the carrying capacity for different storage options.



INCREASED VEHICLE PROTECTION
Get extra protection for higher durability with front vehicle protection, skid plate under the vehicle and reinforced rims.



UNIQUE RALLY EXPERIENCE
A vehicle designed for all-road trips with hand guards, Rally comfort seat for a more reactive rider position, mud flaps and large anti-slip adjustable foot pegs.



RALLY MODE AND TIRES
Allows you to have more flexibility and fun off-pavement by optimizing VSS input and enabling you to perform controlled drifts with adapted all-road tires

¹Choice of one set of Classic Panels included at the vehicle purchase. ²Exclusive Panel Kits are available in limited quantities.

2025 SPYDER F3-S



WHAT'S NEW

- XPS Roadster tires

PACKAGE HIGHLIGHTS

- Open-air freedom
- Relaxed cruiser ergonomics with UFit
- Bold muscular & sporty design
- Spirited performance ride

UFIT / ECO / SPORT MODE / BRP CONNECT / APPLE CARPLAY

MONOLITH BLACK SATIN

ENGINE

Type	Rotax® 1330 ACE™ in-line 3 cylinders, liquid-cooled with electronic fuel injection and electronic throttle control
Bore & stroke	84 x 80 mm (3.31 x 3.14 in.)
Power	115 hp (85.8 kW) @ 7250 RPM
Torque	96 lb-ft. (130.1 Nm) @ 5000 RPM
CO ₂ emissions	155 g/km
Fuel consumption	6.3 l/100 km (37.3 mpg)

TRANSMISSION

Type	Semi-automatic with reverse function
Gears	6-speed

CHASSIS

Front suspension	Double A-arms with anti-roll bar
Front shock type/travel	SACHS' Big-Bore shocks / 129 mm (5.1 in.)
Rear suspension	Swing-arm
Rear shock type/travel	SACHS shock / 132 mm (5.2 in.)
Electronic brake distribution system	Foot-operated, hydraulic 3-wheel brake
Front brakes	270 mm discs with Brembo® 4-piston fixed calipers
Rear brake	270 mm disc, 1-piston floating caliper with integrated parking brake
Parking brake	Electrically actuated
Front tires	XPS Roadster - 165/55 R15 MC 69H
Rear tire	XPS Roadster - 225/50 R15 MC 84H
Aluminum front rims	10-spoke, Deep Black, machined and tinted, 381 x 127 mm (15 x 5 in.)
Aluminum rear rim	6-spoke, 381 mm x 178 mm (15 x 7 in.)

CAPACITY

Rider capacity	2
Maximum vehicle load	199 kg (439 lb)
Storage capacity	24.4 L (6.5 gal)
Fuel capacity	27 L (7.1 gal)
Fuel type	Premium unleaded

DIMENSIONS

L x W x H	2,642 x 1,497 x 1,099 mm (104 x 58.9 x 43.3 in.)
Wheelbase	1,709 mm (67.3 in.)
Seat height	675 mm (26.6 in.)
Ground clearance	115 mm (4.5 in.)
Dry weight	408 kg (899 lb)

INSTRUMENTATION

Type	10.25 in. touchscreen display with BRP Connect and Apple CarPlay
Main functions	Speedometer, tachometer, odometer, trip and hour meters, fuel consumption avg, gear position, ECO mode, Sport mode, temperature, engine lights, electronic fuel gauge, clock and more.
Audio system	USB, Bluetooth*

SAFETY & SECURITY

SCS	Stability Control System
TCS	Traction Control System
ABS	Anti-lock Braking System
DPS™	Dynamic Power Steering
Anti-theft system	Digitally Encoded Security System (D.E.S.S.™)
HHC	Hill Hold Control

COVERAGE

Factory warranty	2-year BRP Limited Warranty
Extended service terms	2-year roadside assistance provided by Allianz Assistance, world leader in Automotive and Travel assistance, on behalf of BRP**

FEATURES

- LED headlights
- Front fender with integrated LED lights
- Cruise control
- Handlebar control module
- Sport mode
- Can-Am Red color frame
- Sport silencer

* Audio output available through accessories (compatible helmet, etc.)

** Available on vehicles registered by an authorized BRP dealer in the United Kingdom, Ireland, France, Netherlands, Belgium, Luxembourg, Germany, Austria, Switzerland, Italy, Spain or Portugal.



*In the UK, you can ride Can-Am 3-Wheel vehicles with a car licence (B) from the age of 21 years old. In Norway, Finland and Sweden, you can ride Can-Am 3-Wheel vehicles with a car licence (B) under certain conditions. More details on A and B licence requirements at canamonroad.com/licence. For all other countries, please ask your local authority.



Feature highlights



UFIT SYSTEM

Can be adjusted to fit the rider's height and style in a short period of time.



10.25 IN. TOUCHSCREEN DISPLAY WITH BRP CONNECT AND APPLE CARPLAY

A high-resolution infotainment system that puts an interactive, informative and customizable experience that's both seamless and simple, right at your fingertips.



VSS SYSTEM

Vehicle Stability System that uses a variety of technologies, including SCS/ABS/TCS, to monitor the vehicle and keep the rider confident on the road



ROTAX 1330 ACE ENGINE

115 hp engine – More power can only mean one thing: better performance. Our most powerful engine allows you to challenge the road knowing you have the horsepower you want when you need it.



LED HEADLIGHTS

The LED headlamps offer whiter illumination and a wider periphery, while reducing the amount of maintenance required. Leave nothing hidden with improved road visibility and precision lighting.



SEMI-AUTOMATIC TRANSMISSION

Shift through gears easily with the touch of a button.

2025 SPYDER F3-T



WHAT'S NEW

- XPS Roadster tires

PACKAGE HIGHLIGHTS

- Open-air freedom
- Relaxed cruiser ergonomics with UFit
- Bold muscular design
- Added cruiser comfort and convenience



PEARL WHITE

ENGINE

Type	Rotax® 1330 ACE™ in-line 3 cylinders, liquid-cooled with electronic fuel injection and electronic throttle control
Bore & stroke	84 x 80 mm (3.31 x 3.14 in.)
Power	115 hp (85.8 kW) @ 7250 RPM
Torque	96 lb-ft. (130.1 Nm) @ 5000 RPM
CO ₂ emissions	155 g/km
Fuel consumption	6.3 l/100 km (37.3 mpg)

TRANSMISSION

Type	Semi-automatic with reverse function
Gears	6-speed

CHASSIS

Front suspension	Double A-arms with anti-roll bar
Front shock type/travel	SACHS® Big-Bore shocks / 129 mm (5.1 in.)
Rear suspension	Swing-arm
Rear shock type/travel	SACHS shock with manual air preload adjustment / 132 mm (5.2 in.)
Electronic brake distribution system	Foot-operated, hydraulic 3-wheel brake
Front brakes	270 mm discs with Brembo® 4-piston fixed calipers
Rear brake	270 mm disc, 1-piston floating caliper with integrated parking brake
Parking brake	Electrically actuated
Front tires	XPS Roadster - 165/55 R15 MC 69H
Rear tire	XPS Roadster - 225/50 R15 MC 84H
Aluminum front rims	10-spoke, Deep Black, 381 x 127 mm (15 x 5 in.)
Aluminum rear rim	6-spoke, 15 x 7 in. (381 mm x 178 mm)

CAPACITY

Rider capacity	2
Maximum vehicle load	199 kg (439 lb)
Storage capacity	79,5 L (21 gal)
Fuel capacity	27 L (7.1 gal)
Fuel type	Premium unleaded

DIMENSIONS

L x W x H	2,596 x 1,497 x 1,241 mm (102.2 x 58.9 x 48.9 in.)
Wheelbase	1,709 mm (67.3 in.)
Seat height	675 mm (26.6 in.)
Ground clearance	115 mm (4.5 in.)
Dry weight	430 kg (948 lb)

INSTRUMENTATION

Type	10.25 in. touchscreen display with BRP Connect and Apple CarPlay
Main functions	Speedometer, tachometer, odometer, trip and hour meters, fuel consumption avg, gear position, ECO mode smart assist, temperature, engine lights, electronic fuel gauge, clock and more.
Audio system	BRP Audio 4-speaker sound system with radio, USB, Bluetooth†

SAFETY & SECURITY

SCS	Stability Control System
TCS	Traction Control System
ABS	Anti-lock Braking System
DPS™	Dynamic Power Steering
Anti-theft system	Digitally Encoded Security System (D.E.S.S.™)
HHC	Hill Hold Control

COVERAGE

Factory warranty	2-year BRP Limited Warranty
Extended service terms	2-year roadside assistance provided by Allianz Assistance, world leader in Automotive and Travel assistance, on behalf of BRP*

FEATURES

- LED headlights
- Front fender with integrated LED lights
- Cruise control
- Handlebar control module
- Sport windshield
- Glove box with USB (1 gal / 3,5 l)
- Integrated hard-side luggage

*Available on vehicles registered by an authorized BRP dealer in the United Kingdom, Ireland, France, Netherlands, Belgium, Luxembourg, Germany, Austria, Switzerland, Italy, Spain or Portugal.



*In the UK, you can ride Can-Am 3-Wheel vehicles with a car licence (B) from the age of 21 years old. In Norway, Finland and Sweden, you can ride Can-Am 3-Wheel vehicles with a car licence (B) under certain conditions. More details on A and B licence requirements at canamonroad.com/licence. For all other countries, please ask your local authority.



Feature highlights



UFIT SYSTEM

Can be adjusted to fit the rider's height and style in a short period of time.



10.25 IN. TOUCHSCREEN DISPLAY WITH BRP CONNECT AND APPLE CARPLAY

A high-resolution infotainment system that puts an interactive, informative and customizable experience that's both seamless and simple, right at your fingertips.



LED HEADLIGHTS

The LED headlamps offer whiter illumination and a wider periphery, while reducing the amount of maintenance required. Leave nothing hidden with improved road visibility and precision lighting.



SADDLEBAGS

Integrated hard side luggage to allow you to take more with you on your adventure.



SPORT WINDSHIELD

Provides protection from the wind for improved comfort on the road.



BRP AUDIO SYSTEM

Our 4-speaker sound system comes equipped with radio, USB and Bluetooth[†] so you can listen to your favourite music from any device.

2025 SPYDER F3 LIMITED



WHAT'S NEW

- XPS Roadster tires

PACKAGE HIGHLIGHTS

- Open-air freedom
- Relaxed cruiser ergonomics with UFit
- Bold muscular design
- Premium cruiser comfort and convenience for two



MINERAL BLUE SATIN - DARK

ENGINE

Type	Rotax® 1330 ACE™ in-line 3 cylinders, liquid-cooled with electronic fuel injection and electronic throttle control
Bore & stroke	3.31 x 3.14 in. (84 x 80 mm)
Power	115 hp (85.8 kW) @ 7250 RPM
Torque	96 lb-ft. (130.1 Nm) @ 5000 RPM
CO ₂ emissions	155 g/km
Fuel consumption	6.3 l/100 km (37.3 mpg)

TRANSMISSION

Type	Semi-automatic with reverse function
Gears	6-speed

CHASSIS

Front suspension	Double A-arms with anti-roll bar
Front shock type/travel	SACHS® Big-Bore shocks / 5.1 in. (129 mm)
Rear suspension	Swing-arm
Rear shock type/travel	SACHS Shock with self-leveling air preload adjustment / 5.2 in. (132 mm)
Electronic brake distribution system	Foot-operated, hydraulic 3-wheel brake
Front brakes	270 mm discs with Brembo® 4-piston fixed calipers
Rear brake	270 mm disc, 1-piston floating caliper with integrated parking brake
Parking brake	Electrically actuated
Front tires	XPS Roadster - 165/55 R15 MC 69H
Rear tire	XPS Roadster - 225/50 R15 MC 84H
Aluminum front rims	10-spoke, Deep Black, 381 x 127 mm (15 x 5 in.)
Aluminum rear rim	6-spoke, 381 mm x 178 mm (15 x 7 in.)

CAPACITY

Rider capacity	2
Maximum vehicle load	199 kg (439 lb)
Storage capacity	139,5 L (36.8 gal)
Fuel capacity	27 L (7.1 gal)
Fuel type	Premium unleaded

DIMENSIONS

L x W x H	2,820 x 1,497 x 1,241 mm (111.0 x 58.9 x 48.9 in.)
Wheelbase	1,709 mm (67.3 in.)
Seat height	675 mm (26.6 in.)
Ground clearance	115 mm (4.5 in.)
Dry weight	448 kg (988 lb)

INSTRUMENTATION

Type	10.25 in. touchscreen display with BRP Connect and Apple CarPlay
Main functions	Speedometer, tachometer, odometer, trip and hour meters, fuel consumption avg, gear position, ECO mode smart assist, temperature, engine lights, electronic fuel gauge, clock and more
Audio system	BRP Audio Premium 6-speaker sound system with radio, USB, Bluetooth†

SAFETY & SECURITY

SCS	Stability Control System
TCS	Traction Control System
ABS	Anti-lock Braking System
DPS™	Dynamic Power Steering
Anti-theft system	Digitally Encoded Security System (D.E.S.S.™)
HHC	Hill Hold Control

COVERAGE

Factory warranty	2-year BRP Limited Warranty
Extended service terms	2-year roadside assistance provided by Allianz Assistance, world leader in Automotive and Travel assistance, on behalf of BRP*

FEATURES

- LED headlights
- Front fender with integrated LED lights
- Cruise control
- Handlebar control module
- Sport windshield
- Glove box with USB (3.5 L. / 1 gal)
- Integrated hard-side luggage
- Top case with integrated passenger backrest (22 L. / 5,8 gal)
- Driver and passenger heated grip
- Driver and passenger footboards

*Available on vehicles registered by an authorized BRP dealer in the United Kingdom, Ireland, France, Netherlands, Belgium, Luxembourg, Germany, Austria, Switzerland, Italy, Spain or Portugal.



*In the UK, you can ride Can-Am 3-Wheel vehicles with a car licence (B) from the age of 21 years old. In Norway, Finland and Sweden, you can ride Can-Am 3-Wheel vehicles with a car licence (B) under certain conditions. More details on A and B licence requirements at canamonroad.com/licence. For all other countries, please ask your local authority.



VEHICLE SPECIFICATIONS

Feature highlights



UFIT SYSTEM

Can be adjusted to fit the rider's height and style in a short period of time.



10.25 IN. TOUCHSCREEN DISPLAY WITH BRP CONNECT AND APPLE CARPLAY

A high-resolution infotainment system that puts an interactive, informative and customizable experience that's both seamless and simple, right at your fingertips.



TOP CASE

The waterproof top case offers 60 liters of storage capacity, perfect for leaving nothing behind on a long-distance ride. Enough space for 2 large full-face helmets.



SELF-LEVELING AIR SUSPENSION

Rear air shocks automatically adjust to passenger and cargo weight to ensure comfort is never compromised.



LED HEADLIGHTS

The LED headlamps offer whiter illumination and a wider periphery, while reducing the amount of maintenance required. Leave nothing hidden with improved road visibility and precision lighting.



BRP AUDIO PREMIUM SYSTEM

Our 6-speaker sound system comes equipped with radio, USB and Bluetooth[®] so you can listen to your favorite music from any device.

2025 SPYDER F3 LIMITED SPECIAL SERIES



WHAT'S NEW

- XPS Roadster tires

PACKAGE HIGHLIGHTS

- Open-air freedom
- Relaxed cruiser ergonomics with Ufit
- Bold muscular & sporty design with premium finishes & colorations
- Ultimate cruiser comfort and convenience for two



BRITISH GREEN METALLIC

ENGINE

Type	Rotax® 1330 ACE™ in-line 3 cylinders, liquid-cooled with electronic fuel injection and electronic throttle control
Bore & stroke	3.31 x 3.14 in. (84 x 80 mm)
Power	115 hp (85.8 kW) @ 7250 RPM
Torque	96 lb.-ft. (130.1 Nm) @ 5000 RPM
CO ₂ emissions	155 g/km
Fuel consumption	6.3 l/100 km (37.3 mpg)

TRANSMISSION

Type	Semi-automatic with reverse function
Gears	6-speed

CHASSIS

Front suspension	Double A-arms with anti-roll bar
Front shock type/travel	SACHS† Big-Bore shocks / 5.1 in. (129 mm)
Rear suspension	Swing-arm
Rear shock type/travel	SACHS Shock with self-leveling air preload adjustment / 5.2 in. (132 mm)
Electronic brake distribution system	Foot-operated, hydraulic 3-wheel brake
Front brakes	270 mm discs with Brembo ¹ 4-piston fixed calipers
Rear brake	270 mm disc, 1-piston floating caliper with integrated parking brake
Parking brake	Electrically actuated
Front tires	XPS Roadster - 165/55 R15 MC 69H
Rear tire	XPS Roadster - 225/50 R15 MC 84H
Aluminum front rims	16-spoke, Carbon Black, 381 x 127 mm (15 x 5 in.)
Aluminum rear rim	6-spoke, 381 mm x 178 mm (15 x 7 in.)

CAPACITY

Rider capacity	2
Maximum vehicle load	199 kg (439 lb)
Storage capacity	(139,5 L (36.8 gal))
Fuel capacity	27 L (7.1 gal)
Fuel type	Premium unleaded

DIMENSIONS

L x W x H	2,820 x 1,497 x 1,241 mm (111.0 x 58.9 x 48.9 in.)
Wheelbase	1,709 mm (67.3 in.)
Seat height	675 mm (26.6 in.)
Ground clearance	115 mm (4.5 in.)
Dry weight	448 kg (988 lb)

INSTRUMENTATION

Type	10.25 in. touchscreen display with BRP Connect and Apple CarPlay
Main functions	Speedometer, tachometer, odometer, trip and hour meters, fuel consumption avg, gear position, ECO mode smart assist, temperature, engine lights, electronic fuel gauge, clock and more
Audio system	BRP Audio Premium 6-speaker sound system with radio, USB, Bluetooth ¹

SAFETY & SECURITY

SCS	Stability Control System
TCS	Traction Control System
ABS	Anti-lock Braking System
DPS™	Dynamic Power Steering
Anti-theft system	Digitally Encoded Security System (D.E.S.S.™)
HHC	Hill Hold Control

COVERAGE

Factory warranty	2-year BRP Limited Warranty
Extended service terms	2-year roadside assistance provided by Allianz Assistance, world leader in Automotive and Travel assistance, on behalf of BRP*

FEATURES

- LED headlights
- Front fender with integrated LED lights
- Cruise control
- Handlebar control module
- Sport windshield
- Glove box with USB (3.5 L. / 1 gal)
- Integrated hard-side luggage
- Top case with integrated passenger backrest (22 L. / 5,8 gal)
- Driver and passenger heated grip
- Driver and passenger footboards
- Short reach handlebar
- Top case rack
- Adjustable driver backrest
- Comfort seat

*Available on vehicles registered by an authorized BRP dealer in the United Kingdom, Ireland, France, Netherlands, Belgium, Luxembourg, Germany, Austria, Switzerland, Italy, Spain or Portugal. 2025



*In the UK, you can ride Can-Am 3-Wheel vehicles with a car licence (B) from the age of 21 years old. In Norway, Finland and Sweden, you can ride Can-Am 3-Wheel vehicles with a car licence (B) under certain conditions. More details on A and B licence requirements at canamonroad.com/licence. For all other countries, please ask your local authority.



VEHICLE SPECIFICATIONS

Feature highlights



DRIVER BACKREST AND SHORT-REACH HANDLEBAR

Lean back, relax and enjoy the ride with the combination of the comfort seat, the short reach handlebar and the adjustable driver backrest that allow a more relaxed cruising position



10.25 IN. TOUCHSCREEN DISPLAY WITH BRP CONNECT AND APPLE CARPLAY

A high-resolution infotainment system that puts an interactive, informative and customizable experience that's both seamless and simple, right at your fingertips.



TOP CASE

The waterproof top case offers 60 liters of storage capacity, perfect for leaving nothing behind on a long-distance ride. Enough space for 2 large full-face helmets.



SELF-LEVELING AIR SUSPENSION

Rear air shocks automatically adjust to passenger and cargo weight to ensure comfort is never compromised.



BACK-UP CAMERA

Improve user visibility when the vehicle is in reverse. Easy to use, the camera automatically appears on your screen when you put the vehicle on reverse.



BRP AUDIO PREMIUM SYSTEM

Our 6-speaker sound system comes equipped with radio, USB and Bluetooth[†] so you can listen to your favorite music from any device.

2025 SPYDER RT LIMITED



WHAT'S NEW

- XPS Roadster tires

PACKAGE HIGHLIGHTS

- Ultimate touring vehicle for two
- Modern design
- Ultimate comfort for two
- Next-level convenience and versatility

BRP AUDIO PREMIUM / BRP CONNECT / APPLE CARPLAY / ECO

- HYPER SILVER METALLIC
- CARBON BLACK
- MINERAL BLUE SATIN

ENGINE

Type	Rotax® 1330 ACE™ in-line 3 cylinders, liquid-cooled with electronic fuel injection and electronic throttle control
Bore & stroke	3.31 x 3.14 in. (84 x 80 mm)
Power	115 hp (85.8 kW) @ 7250 RPM
Torque	96 lb-ft. (130.1 Nm) @ 5000 RPM
CO ₂ emissions	155 g/km
Fuel consumption	6.3 l/100 km (37.3 mpg)

TRANSMISSION

Type	Semi-automatic with reverse function
Gears	6-speed

CHASSIS

Front suspension	Double A-arms with anti-roll bar
Front shock type/travel	SACHS ¹ Big-Bore shocks / 6.9 in. (174 mm)
Rear suspension	Swing-arm
Rear shock type/travel	SACHS ¹ Shock with self-leveling air preload adjustment / 6 in. (152 mm)
Electronic brake distribution system	Foot-operated, hydraulic 3-wheel brake
Front brakes	270 mm discs with Brembo ⁴ 4-piston fixed calipers
Rear brake	270 mm disc, 1-piston floating caliper with integrated parking brake
Parking brake	Electrically actuated
Front tires	XPS Roadster - 165/55 R15 MC 69H
Rear tire	XPS Roadster - 225/50 R15 MC 84H
Aluminum front rims	6-spoke, 15 x 5 in. (381 x 127 mm)
Aluminum rear rim	6-spoke, 15 x 7 in. (381 mm x 178 mm)

CAPACITY

Rider capacity	2
Maximum vehicle load	494 lb (224 kg)
Storage capacity	47 gal (177 L)
Fuel capacity	7 gal (26,5 L)
Fuel type	Premium unleaded

DIMENSIONS

L x W x H	111.5 x 61.2 x 57.6 in. (2,833 x 1,554 x 1,464 mm)
Wheelbase	67.5 in. (1,714 mm)
Seat height	29.7 in. (755 mm)
Ground clearance	4.5 in. (115 mm)
Dry weight	1,021 lb (464 kg)

INSTRUMENTATION

Type	10.25 in. touchscreen display with BRP Connect and Apple CarPlay
Main functions	Speedometer, tachometer, odometer, trip and hour meters, fuel consumption avg, gear position, ECO mode smart assist, temperature, engine lights, electronic fuel gauge, clock, and more.
Audio system	BRP Audio Premium 6-speaker sound system with radio, USB, Bluetooth ¹

SAFETY & SECURITY

SCS	Stability Control System
TCS	Traction Control System
ABS	Anti-lock Braking System
DPS™	Dynamic Power Steering
Anti-theft system	Digitally Encoded Security System (D.E.S.S.™)
HHC	Hill Hold Control

COVERAGE

Factory warranty	2-year BRP Limited Warranty
Extended service terms	2-year roadside assistance provided by Allianz Assistance, world leader in Automotive and Travel assistance, on behalf of BRP*

FEATURE HIGHLIGHTS

Premium LED headlights
 Driver Touring Floorboards
 Adjustable passenger footboards
 Handlebar control module
 Ultra comfortable seat with lumbar support
 Glove box with USB (0.36 gal)
 Cruise control
 Integrated hard-side luggage
 Adjustable electric windshield with memory
 LinQ compatible
 Fixed side wind deflectors
 Driver and passenger heated grip
 Driver and passenger heated seat
 Top case with integrated passenger backrest (22 l / 5,8 gal)



*In the UK, you can ride Can-Am 3-Wheel vehicles with a car licence (B) from the age of 21 years old. In Norway, Finland and Sweden, you can ride Can-Am 3-Wheel vehicles with a car licence (B) under certain conditions. More details on A and B licence requirements at canamonroad.com/licence. For all other countries, please ask your local authority.



Feature highlights



10.25 IN. TOUCHSCREEN DISPLAY WITH BRP CONNECT AND APPLE CARPLAY

A high-resolution infotainment system that puts an interactive, informative and customizable experience that's both seamless and simple, right at your fingertips.



TOURING FLOORBOARDS

With the 23 in. (58.4 cm) touring floorboards, riders can now sit however they are most comfortable and change leg positions on long rides while enjoying easy access to the brakes.



TOP CASE

The waterproof top case offers 60 liters of storage capacity, perfect for leaving nothing behind on a long-distance ride. Enough space for 2 large full-face helmets.



ADJUSTABLE ELECTRIC WINDSHIELD

The adjustable electric windshield with memory function provides superior wind protection, and the memory function automatically returns the windshield to the lowest or previous height.

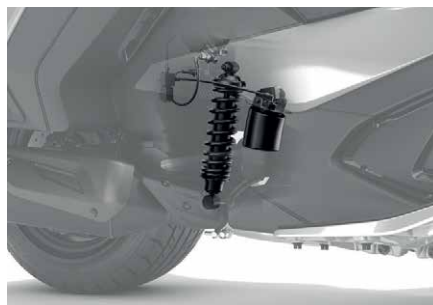

SELF-LEVELING AIR SUSPENSION

Rear air shocks automatically adjust to passenger and cargo weight to ensure comfort is never compromised.

*Available on vehicles registered by an authorized BRP dealer in the United Kingdom, Ireland, France, Netherlands, Belgium, Luxembourg, Germany, Austria, Switzerland, Italy, Spain or Portugal.

2025 SPYDER RT SEA-TO-SKY



WHAT'S NEW

- XPS Roadster tires
- Back-up camera
- Dusk Metallic coloration

PACKAGE HIGHLIGHTS

- Ultimate luxury touring vehicle for two
- Modern design
- Ultimate comfort and convenience for two
- Exclusive styling and badging

BRP AUDIO PREMIUM / BRP CONNECT / APPLE CARPLAY / ECO

DUSK METALLIC

ENGINE

Type	Rotax® 1330 ACE™ in-line 3 cylinders, liquid-cooled with electronic fuel injection and electronic throttle control
Bore & stroke	84 x 80 mm (3.31 x 3.14 in.)
Power	115 hp (85.8 kW) @ 7250 RPM
Torque	96 lb-ft. (130.1 Nm) @ 5000 RPM
CO ₂ emissions	155 g/km
Fuel consumption	6.3 l/100 km (37.3 mpg)

TRANSMISSION

Type	Semi-automatic with reverse function
Gears	6-speed

CHASSIS

Front suspension	Double A-arms with anti-roll bar
Front shock type/travel	SACHS† Big-Bore shocks / 174 mm (6.9 in.)
Rear suspension	Swing-arm
Rear shock type/travel	SACHS† Shock with self-leveling air preload adjustment / 152 mm (6 in.)
Electronic brake distribution system	Foot-operated, hydraulic 3-wheel brake
Front brakes	270 mm discs with Brembo† 4-piston fixed calipers
Rear brake	270 mm disc, 1-piston floating caliper with integrated parking brake
Parking brake	Electrically actuated
Front tires	XPS Roadster - 165/55 R15 MC 69H
Rear tire	XPS Roadster - 225/50 R15 MC 84H
Aluminum front rims	381 x 127 mm (16-spoke, Moka, 15 x 5 in.)
Aluminum rear rim	381 mm x 178 mm (6-spoke, 15 x 7 in.)

CAPACITY

Rider capacity	2
Maximum vehicle load	224 kg (494 lb)
Storage capacity	177 L (47 gal)
Fuel capacity	26,5 L (7 gal)
Fuel type	Premium unleaded

DIMENSIONS

L x W x H	2,833 x 1,554 x 1,464 mm (111.5 x 61.2 x 57.6 in.)
Wheelbase	1,714 mm (67.5 in.)
Seat height	755 mm (29.7 in.)
Ground clearance	115 mm (4.5 in.)
Dry weight	464 kg (1,021 lb)

INSTRUMENTATION

Type	10.25 in. touchscreen display with BRP Connect and Apple CarPlay
Main functions	Speedometer, tachometer, odometer, trip and hour meters, fuel consumption avg, gear position, ECO mode smart assist, temperature, engine lights, electronic fuel gauge, clock, and more.
Audio system	BRP Audio Premium 6-speaker sound system with radio, USB, Bluetooth†

SAFETY & SECURITY

SCS	Stability Control System
TCS	Traction Control System
ABS	Anti-lock Braking System
DPS™	Dynamic Power Steering
Anti-theft system	Digitally Encoded Security System (D.E.S.S.™)
HHC	Hill Hold Control

COVERAGE

Factory warranty	2-year BRP Limited Warranty
Extended service terms	2-year roadside assistance provided by Allianz Assistance, world leader in Automotive and Travel assistance, on behalf of BRP*

FEATURES

Premium LED headlights	Adjustable side wind deflectors
Driver Touring Floorboards	Driver and passenger heated seat
Adjustable passenger footboards	Driver and passenger heated seat
Handlebar control module	Top case with integrated passenger backrest (22 L / 5,8 gal)
Ultra comfortable seat with lumbar support	Adaptive foam seat with Sea-to-Sky embroidery
Glove box with USB (1.36 L. / 0.36 gal)	Unique Sea-to-sky badges and colors
Cruise control	Colored rear panel
Integrated hard-side luggage	Adjustable driver backrest
Adjustable electric windshield with memory	
LinQ compatible	



*In the UK, you can ride Can-Am 3-Wheel vehicles with a car licence (B) from the age of 21 years old. In Norway, Finland and Sweden, you can ride Can-Am 3-Wheel vehicles with a car licence (B) under certain conditions. More details on A and B licence requirements at canamonroad.com/licence. For all other countries, please ask your local authority.



Feature highlights



10.25 IN. TOUCHSCREEN DISPLAY WITH BRP CONNECT AND APPLE CARPLAY

A high-resolution infotainment system that puts an interactive, informative and customizable experience that's both seamless and simple, right at your fingertips.



ULTRA COMFORTABLE SEATS

Ride long distances in comfort with the ultra comfortable adaptive foam seats and adjustable driver backrest, stylized with a Sea-to-Sky embroidery. On colder days, keep warm with the heated feature.



ADJUSTABLE SIDE WIND DEFLECTORS

Regulate driver and passenger lower-body airflow. Change to closed, open or parallel position for optimal comfort. Simple, tool-free adjustment so you can spend more time riding.



COLOR REAR PANEL

Swap the top case with the rear panel for a sportier look.



BACK-UP CAMERA

Improve user visibility when the vehicle is in reverse. Easy to use, the camera automatically appears on your screen when you put the vehicle on reverse.



SEA-TO-SKY UNIQUE COLORATION AND WHEELS

The new Dusk Metallic coloration give a unique and modern style combined with the 16-spoke Moka color wheels. A combination that will make heads turn.

*Available on vehicles registered by an authorized BRP dealer in the United Kingdom, Ireland, France, Netherlands, Belgium, Luxembourg, Germany, Austria, Switzerland, Italy, Spain or Portugal.

2025 CANYON



PACKAGE HIGHLIGHTS

- LinQ integration for easy accessorisation
- Adventure ready 3 wheel vehicle
- Impressive stability in any type of road
- Perfect for solo rider

BRP CONNECT / APPLE CARPLAY / SPORT MODE / RALLY MODE / ALL-ROAD MODE

STERLING SILVER SATIN

ENGINE

Type	Rotax® 1330 ACE™ in-line 3 cylinders, liquid-cooled with electronic fuel injection and electronic throttle control
Bore & stroke	84 x 80 mm (3.31 x 3.14 in.)
Power	115 hp (85.8 kW) @ 7250 RPM
Torque	96 lb-ft. (130.1 Nm) @ 5000 RPM

TRANSMISSION

Type	Semi-automatic with reverse function
Gears	6-speed

CHASSIS

Front suspension	Double A-arms with anti-roll bar
Front shock type/travel	SACHS [†] Big-Bore shocks / 260 mm (10.2 in.)
Rear suspension	Swing Arm
Rear shock type/travel	SACHS shock / 235 mm (9.2 in.)
Electronic brake distribution system	Foot-operated, hydraulic 3-wheel brake
Front brakes	270 mm discs with Brembo [†] , 4-piston fixed caliper
Rear brake	270 mm disc, 1-piston floating caliper with integrated parking brake
Parking brake	Electrically actuated
Front tires	XPS Adventure - 155/65 R16 MC 72H
Rear tire	XPS Adventure - 225/50 R15 MC 84H
Aluminum front rims	12-spoke, Carbon Black, 406 x 127 mm (16 x 5 in.)
Aluminum rear rim	6-spoke, 381 mm x 178 mm (15 x 7 in.)

CAPACITY

Rider capacity	2
Maximum vehicle load	298 kg (656 lbs)
Storage capacity	0,6 L (Glove Box)
Fuel capacity	27 L (7.1 gal)
Fuel type	Premium unleaded

DIMENSIONS

L x W x H	2489 x 1581 x 1500 mm (98 x 62.2 X 59 in.)
Wheelbase	1718 mm (67.6 in.)
Seat height	843 mm (33.2 in.)
Ground clearance	169 mm (6.65 in.)
Curb weight	452 kg (996 lbs)

INSTRUMENTATION

Type	10.25 in. touchscreen display with BRP Connect and Apple CarPlay
Main functions	Speedometer, tachometer, odometer, trip and hour meters, fuel consumption avg, gear position, Drive mode, temperature, engine lights, electronic fuel gauge, clock and more.
Audio system*	USB, Bluetooth [†]

SAFETY & SECURITY

SCS	Stability Control System
TCS	Traction Control System
ABS	Anti-lock Braking System
DPS™	Dynamic Power Steering
Anti-theft system	Digitally Encoded Security System (D.E.S.S.™)
HHC	Hill Hold Control

COVERAGE

Factory warranty	2-year BRP Limited Warranty
Extended service terms	2-year roadside assistance provided by Allianz Assistance, world leader in Automotive and Travel assistance, on behalf of BRP**

FEATURES

LED headlights
Metal radiator grille
Adjustable windshield
Glove box with USB cable
Hand guards
Integrated LinQ attachment points
Cruise control
Enduro anti-slip pegs
Adjustable Drive modes
Belt protector
143 mm (5.6 in) Handlebar riser



*In the UK, you can ride Can-Am 3-Wheel vehicles with a car licence (B) from the age of 21 years old. In Norway, Finland and Sweden, you can ride Can-Am 3-Wheel vehicles with a car licence (B) under certain conditions. More details on A and B licence requirements at canamonroad.com/licence. For all other countries, please ask your local authority.

Feature highlights



LINQ ACCESSORIZATION READY

Fully integrated LinQ system with more than 20 anchor points to easily accessorize your Can-Am Canyon with everything you need. Integrated tool-less and robust system.



10.25 IN. TOUCHSCREEN DISPLAY WITH BRP CONNECT AND APPLE CARPLAY

A high-resolution infotainment system that puts an interactive, informative and customizable experience that's both seamless and simple, right at your fingertips.



ADJUSTABLE WINDSHIELD

Robust windshield to protect you from the elements for more comfort during your long adventure. Adjust it manually to perfectly fit your preference.



DRIVES MODES

4 different Drive modes to adapt the engine, stability system and power steering to match the type of road ahead and your riding style.



VEHICLE PROTECTION

Extra protection on the vehicle such as hand guards, metal radiator grille, adventure wheels and belt protector to overcome any road in confidence.



ADAPTED FOR ALL-ROADS

The anti-slip pegs combined with the handlebar riser allows the driver to easily stand up and better absorb uneven road. High suspension travel to overcome obstacles in comfort.

Extensive accessory options



1 LinQ Nano tank bag (219401173)



2 LinQ saddlebags (219401282)



3 LinQ 36" Adventure Plate (219401183)

Select between more than 40 possible accessories to suit all your needs for your next adventure! The integration of the LinQ system with LinQ Nano, LinQ Lite and LinQ 16" anchor points for an easy, versatile and robust accessorization of the Can-Am Canyon.

* Audio output available through accessories (compatible helmet, etc.)

**Available on vehicles registered by an authorized BRP dealer in the United Kingdom, Ireland, France, Netherlands, Belgium, Luxembourg, Germany, Austria, Switzerland, Italy, Spain or Portugal.

2025 CANYON XT



PACKAGE HIGHLIGHTS

- Aluminum top and side cases
- Adventure ready 3-wheel vehicle
- Impressive stability and enhanced rear suspension
- Comfort and convenience for two
- LinQ integration for easy accessorization

BRP CONNECT / **SPORT** / **RALLY** / **ALL-ROAD**
APPLE CARPLAY / **MODE** / **MODE** / **MODE** /

STERLING SILVER SATIN

ENGINE

Type	Rotax® 1330 ACE™ in-line 3 cylinders, liquid-cooled with electronic fuel injection and electronic throttle control
Bore & stroke	84 x 80 mm (3.31 x 3.14 in.)
Power	115 hp (85.8 kW) @ 7250 RPM
Torque	96 lb-ft. (130.1 Nm) @ 5000 RPM

TRANSMISSION

Type	Semi-automatic with reverse function
Gears	6-speed

CHASSIS

Front suspension	Double A-arms with anti-roll bar
Front shock type/travel	SACHS ¹ Big-Bore shocks / 260 mm (10.2 in.)
Rear suspension	Swing Arm
Rear shock type/travel	SACHS Shock with self-leveling air preload adjustment / 235 mm (9.2 in.)
Electronic brake distribution system	Foot-operated, hydraulic 3-wheel brake
Front brakes	270 mm discs with Brembo ² , 4-piston fixed caliper
Rear brake	270 mm disc, 1-piston floating caliper with integrated parking brake
Parking brake	Electrically actuated
Front tires	XPS Adventure - 155/65 R16 MC 72H
Rear tire	XPS Adventure - 225/50/R15 MC 84H
Aluminum front rims	12-spoke, Carbon Black, 406 x 127 mm (16 x 5 in.)
Aluminum rear rim	6-spoke, 381 mm x 178 mm (15 x 7 in.)

CAPACITY

Rider capacity	2
Maximum vehicle load	280 kg (617 lb)
Storage capacity	120,6 L (31.86 gal)
Fuel capacity	27 L (7.1 gal)
Fuel type	Premium unleaded

DIMENSIONS

L x W x H	2547 x 1581 x 1500 mm (100.3 x 62.2 x 59 in.)
Wheelbase	1718 mm (67.6 in.)
Seat height	843 mm (33.2 in.)
Ground clearance	169 mm (6.65 in.)
Curb weight	470 kg (1036 lbs)

INSTRUMENTATION

Type	10.25 in. touchscreen display with BRP Connect and Apple CarPlay
Main functions	Speedometer, tachometer, odometer, trip and hour meters, fuel consumption avg, gear position, Drive mode, temperature, engine lights, electronic fuel gauge, clock and more.
Audio system*	USB, Bluetooth [†]

SAFETY & SECURITY

SCS	Stability Control System
TCS	Traction Control System
ABS	Anti-lock Braking System
DPS™	Dynamic Power Steering
Anti-theft system	Digitally Encoded Security System (D.E.S.S.™)
HHC	Hill Hold Control

COVERAGE

Factory warranty	2-year BRP Limited Warranty
Extended service terms	2-year roadside assistance provided by Allianz Assistance, world leader in Automotive and Travel assistance, on behalf of BRP**

FEATURES

LED headlights	143 mm (5.6 in) Handlebar riser
Metal radiator grille	Aluminum top & side case
Adjustable windshield	Driver and passenger heated grips
Glove box with USB cable	Passenger backrest
Hand guards	Self-leveling rear air suspension
Integrated LinQ attachment points	Comfort pegs
Cruise control	Front Skid plate
Enduro anti-slip pegs	Comfort seat
Adjustable Drive modes	
Belt protector	



*In the UK, you can ride Can-Am 3-Wheel vehicles with a car licence (B) from the age of 21 years old. In Norway, Finland and Sweden, you can ride Can-Am 3-Wheel vehicles with a car licence (B) under certain conditions. More details on A and B licence requirements at canamonroad.com/licence. For all other countries, please ask your local authority.

Feature highlights



ALUMINUM SIDE & TOP CASE

Robust aluminum top and side cases that provide an extra 120 L/31.7 gal storage capacity to bring everything you need during your adventure! Easily removable when you want to change the configuration of your Can-Am Canyon.



SELF-LEVELING AIR SUSPENSION

Rear air shocks automatically adjust to passenger and cargo weight to ensure comfort is never compromised.



COMFORT PEGS

Enduro pegs with removable comfort pads for the driver and passenger. Perfect for longer adventures.



COMFORT SEAT

Comfort driver and passenger seats with thicker foam built for your long expedition.



PASSENGER BACKREST

2-up ready with a passenger backrest, just lean back and enjoy the ride in comfort.



HEATED GRIP

Heated grip for the driver and passenger with different level intensity to keep you warm in colder weather. Separate controls for passenger and driver to adjust heat to your preference.

Extensive accessory options



1 Full-height windshield
(219401174)



2 Driver backrest
(219401176)



3 Premium heated seat
(219401177)



4 Passenger backrest (219401194)

Select between more than 40 possible accessories to suit all your needs for your next adventure!

The integration of the LinQ system with LinQ Nano, LinQ Lite and LinQ 16" anchor points for an easy, versatile and robust accessorization of the Can-Am Canyon.

* Audio output available through accessories (compatible helmet, etc.)

**Available on vehicles registered by an authorized BRP dealer in the United Kingdom, Ireland, France, Netherlands, Belgium, Luxembourg, Germany, Austria, Switzerland, Italy, Spain or Portugal.

2025 CANYON REDROCK



PACKAGE HIGHLIGHTS

- Premium aluminum top and side cases
- Enhanced visibility with back-up camera
- Top of the line semi-active suspension: Smart-Shox
- Comfort and convenience for two
- LinQ integration for easy accessorization

BRP CONNECT / **SPORT** / **RALLY** / **ALL-ROAD** / **CUSTOM**
APPLE CARPLAY / **MODE** / **MODE** / **MODE** / **MODE**

MOSS GREEN SATIN

ENGINE

Type	Rotax® 1330 ACE™ in-line 3 cylinders, liquid-cooled with electronic fuel injection and electronic throttle control
Bore & stroke	84 x 80 mm (3.31 x 3.14 in.)
Power	115 hp (85.8 kW) @ 7250 RPM
Torque	96 lb.-ft. (130.1 Nm) @ 5000 RPM

TRANSMISSION

Type	Semi-automatic with reverse function
Gears	6-speed

CHASSIS

Front suspension	Double A-arms with anti-roll bar
Front shock type/travel	SACHS ¹ Big-Bore shocks / 260 mm (10.2 in.)
Rear suspension	Swing Arm
Rear shock type/travel	KYB Smart-Shox with self-leveling air preload adjustment / 9.2 po (235 mm)
Electronic brake distribution system	Foot-operated, hydraulic 3-wheel brake
Front brakes	270 mm discs with Brembo ¹ , 4-piston fixed caliper
Rear brake	270 mm disc, 1-piston floating caliper with integrated parking brake
Parking brake	Electrically actuated
Front tires	XPS Adventure - 155/65 R16 MC 72H
Rear tire	XPS Adventure - 225/50/R15 MC 84H
Aluminum front rims	12-spoke, Carbon Black / Alloy Orange, 406 x 127 mm (16 x 5 in.)
Aluminum rear rim	6-spoke, 381 mm x 178 mm (15 x 7 in.)

CAPACITY

Rider capacity	2
Maximum vehicle load	280 kg (617 lb)
Storage capacity	120,6 L (31.86 gal)
Fuel capacity	27 L (7.1 gal)
Fuel type	Premium unleaded

DIMENSIONS

L x W x H	2547 x 1581 x 1500 mm (100.3 x 62.2 x 59 in.)
Wheelbase	1718 mm (67.6 in.)
Seat height	843 mm (33.2 in.)
Ground clearance	169 mm (6.65 in.)
Curb weight	470 kg (1036 lbs)

INSTRUMENTATION

Type	10.25 in. touchscreen display with BRP Connect and Apple CarPlay
Main functions	Speedometer, tachometer, odometer, trip and hour meters, fuel consumption avg, gear position, Drive mode, Custom Mode, temperature, engine lights, electronic fuel gauge, clock and more.
Audio system*	USB, Bluetooth ¹

SAFETY & SECURITY

SCS	Stability Control System
TCS	Traction Control System
ABS	Anti-lock Braking System
DPS™	Dynamic Power Steering
Anti-theft system	Digitally Encoded Security System (D.E.S.S.™)
HHC	Hill Hold Control

COVERAGE

Factory warranty	2-year BRP Limited Warranty
Extended service terms	2-year roadside assistance provided by Allianz Assistance, world leader in Automotive and Travel assistance, on behalf of BRP**

FEATURES

LED headlights	Custom drive modes
Metal radiator grille	Aluminium top & side case
Adjustable windshield	Driver and passenger heated grips
Glove box with USB cable	Passenger backrest
Hand guards	Self-leveling rear air suspension
Integrated LinQ attachment points	Comfort pegs
Cruise control	Front Skid plate
Enduro anti-slip pegs	Comfort seat
Adjustable Drive modes	Back-up camera
Belt protector	Smart-Shox Semi-activ suspension
143 mm (5.6 in) Handlebar riser	

* Audio output available through accessories (compatible helmet, etc.)

**Available on vehicles registered by an authorized BRP dealer in the United Kingdom, Ireland, France, Netherlands, Belgium, Luxembourg, Germany, Austria, Switzerland, Italy, Spain or Portugal.



*In the UK, you can ride Can-Am 3-Wheel vehicles with a car licence (B) from the age of 21 years old. In Norway, Finland and Sweden, you can ride Can-Am 3-Wheel vehicles with a car licence (B) under certain conditions. More details on A and B licence requirements at canamonroad.com/licence. For all other countries, please ask your local authority.

Feature highlights



PREMIUM ALUMINUM SIDE & TOP CASE

Robust aluminum top and side cases that provide an extra 120 L / 31.7 gal storage capacity to bring everything you need during your adventure! Easily removable when you want to change the configuration of your Can-Am Canyon.



SEMI-ACTIVE SUSPENSION : SMART-SHOX

High-capacity KYB front and rear Smart-Shox constantly adapt shock compression and rebound to the terrain and vehicle movements, thanks to multiple sensors placed all around the vehicle.



PREMIUM COMFORT SEAT

Comfort seat for the driver and passenger to overcome any type of road in comfort during your long adventure. The unique coloration and texture complete this Premium Can-Am Canyon package.



REDROCK COLORATION & TRIMS

Premium and unique Moss Green Satin coloration for a head-turning look combined with unique parts and trims coloration.



BACK-UP CAMERA

Improve user visibility when the vehicle is in reverse. Easy to use, the camera automatically appears on your screen when you put the vehicle on reverse.



CUSTOM DRIVE MODE

In addition to the 4 Drive Modes, the Canyon Redrock allows you to create and save a personalized Drive Mode, adjusting the stability system, power steering, engine and even suspension to suit your preferences.

Extensive accessory options



1 Headlight Protector
(219401171)



2 Handguard Deflectors
(219401186)



3 Adventure Front Bumper
(219401193)





4 Fixed Riser -6 in. (155 mm)
(219401211)





5 LinQ sport bag
(860202447)



Select between more than 40 possible accessories to suit all your needs for your next adventure! The integration of the LinQ system with LinQ Nano, LinQ Lite and LinQ 16" anchor points for an easy, versatile and robust accessorization of the Can-Am Canyon.

COMPARATIVE CHART

		RYKER	RYKER SPORT	RYKER RALLY	
					
Color Options		Black		Black	
ENGINE	Type	Rotax® 600 ACE™ in-line 2 cylinders, liquid-cooled with electronic fuel injection and electronic throttle control	Rotax® 900 ACE™ in-line 3 cylinders, liquid-cooled with electronic fuel injection and electronic throttle control	Rotax® 900 ACE™ in-line 3 cylinders, liquid-cooled with electronic fuel injection and electronic throttle control	
	Bore & stroke	74 x 69.7 mm (2.9 x 2.7 in.)			
	Power	50 hp (37.3 kW) @ 7300 RPM	82 hp (61.1 kW) @ 8000 RPM	82 hp (61.1 kW) @ 8000 RPM	82 hp (61.1 kW) @ 8000 RPM
	Torque	36.7 lb-ft (49.7 Nm) @ 6000 RPM	58.3 lb-ft (79.1 Nm) @ 6500 RPM	58.3 lb-ft (79.1 Nm) @ 6500 RPM	58.3 lb-ft (79.1 Nm) @ 6500 RPM
TRANSMISSION	Type	Automatic (CVT) with reverse function			
	Gears				
CHASSIS	Front suspension	Double wishbone			
	Front shock type/travel	SACHS® Twin-tube coil-over shocks / 136 mm (5.35 in.)	KYB® HPG with preload adjustment 161 mm (6.34 in.)	KYB HPG with remote reservoir 4-positions compression adjustable damping and preload adjustment / 185 mm (7.28 in.)	
	Rear suspension	Multi-link - mono swing arm			
	Rear shock type/travel	SACHS® Twin-tube coil-over shocks with preload adjustment / 145 mm. (5.71 in.)	KYB HPG with remote reservoir 4-positions compression adjustable damping and preload adjustment / 169 mm. (6.65 in.)	KYB HPG with remote reservoir 4-positions compression adjustable damping and preload adjustment / 179 mm. (7.05 in.)	
	Front brakes	270 mm discs with Nissin 2-piston floating calipers			
	Rear brake	220 mm disc, 1-piston floating caliper			
	Parking brake	Park lock			
	Front tires	XPS Ride - 145/60 R16 MC 66T		XPS Rally - 145/60 R16 MC 66T	
	Rear tire	XPS Ride - 205/45 R16 MC 77T		XPS Rally - 205/55 R15 MC 81T	
	Aluminum front rims	10-spoke, Platinum silver, 406 x 114 mm. (16 x 4.5 in.)	5-spoke, Deep Black, machined and tinted, 406 x 114 mm (16 x 4.5 in.)	15-spoke, Hyper Silver, 406 x 114 mm. (16 x 4.5 in.)	
Aluminum rear rim	10-spoke, Platinum silver, 406 x 165 mm. (16 x 6.5 in.)	5-spoke, Deep Black, machined and tinted, 406 x 165 mm. (16 x 6.5 in.)	15-spoke, Hyper Silver, 381 x 165 mm. (15 x 6.5 in.)		
CAPACITY	Rider capacity	1			
	Maximum vehicle load	204 kg (449.7 lb)	199 kg (438.7 lb)	187 kg (412.2 lb)	
	Storage capacity	7 L. (1.85 gal)			
	Fuel capacity	20 L. (5.28 gal)			
	Fuel type	Premium unleaded			
DIMENSIONS	L x W x H	2,352 x 1,522 x 1,063 mm (92.6 x 59.9 x 41.9 in.)	2,352 x 1,522 x 1,060 mm (92.6 x 59.9 x 41.7 in.)	2,362 x 1,522 x 1,073 mm (92.6 x 59.9 x 42.2 in.)	2,532 x 1,522 x 1,090 mm (92.6 X 59.9 X 42.9 in.)
	Wheelbase	1,709 mm (67.3 in.)			
	Seat height	599 mm (23.6 in.)	597 mm (23.5 in.)	629 mm (24.7 in.)	676 mm (26.6 in.)
	Ground clearance	97 mm (3.8 in.)		101 mm (4.0 in.)	122 mm (4.8 in.)
	Dry weight	270 kg (594 lb)	280 kg (616 lb)	291 kg (642 lb)	303 kg (668 lb)
INSTRUMENTATION	Type	11.4 cm (4.5 in.) digital display			
	Main functions	Speedometer, tachometer, odometer, trips, distance to empty, engine lights, fuel gauge, clock	Speedometer, tachometer, odometer, trips, distance to empty, engine lights, fuel gauge, clock, ECO mode and Sport mode	Speedometer, tachometer, odometer, trips, distance to empty, engine lights, fuel gauge, clock, ECO mode and Sport mode.	Speedometer, tachometer, odometer, trips, distance to empty, engine lights, fuel gauge, clock, ECO mode and Rally mode
	Audio System				
SAFETY & SECURITY	SCS	Stability Control System			
	TCS	Traction Control System			
	ABS	Anti-lock Braking System			
	DPS™				
	Anti-theft system	Digitally Encoded Security System (D.E.S.S.™)			
	HHC	Hill Hold Control			
FEATURES		2 halogen headlamps (55 W), Front fenders with integrated LED lights, Dual USB port, Glove box (1.8 gal / 6.8 l), Full rear fender, Adaptive foam waterproof seat, Sport mode*	2 halogen headlamps (55 W), Front fenders with integrated LED lights, Dual USB port, Glove box (1.8 gal / 6.8 l), Full rear fender, MAX Mount Structure, Cruise control, Sport mode, Sport comfort seat, Sport style trims and finishes	2 halogen headlamps (55 W), Front fenders with integrated LED lights, Dual USB port, Glove box (1.8 gal / 6.8 l), Rally mud flaps, MAX Mount Structure, Cruise control, Rally mode, Rally comfort seat, Hand guards, Akrapovič exhaust, Rally handlebar, Adjustable large anti-slip foot pegs, Front suspension protection, Skid plate, Air intake with pre-filter, Front grille protection, Reinforced rims	
		*Only on Rotax 900 ACE Engine option			

SPYDER F3-S	SPYDER F3-T	SPYDER F3 LIMITED
		
Monolith Black Satin	Pearl White	Mineral Blue Satin - Dark
Rotax® 1330 ACE™ in-line 3 cylinders, liquid-cooled with electronic fuel injection and electronic throttle control		
84 x 80 mm (3.31 x 3.14 in.)		
115 hp (85.8 kW) @ 7250 RPM		
96 lb-ft. (130.1 Nm) @ 5000 RPM		
Semi-automatic with reverse function		
6-speed		
Double A-arms with anti-roll bar		
SACHS® Big-Bore shocks / 129 mm (5.1 in.)		
Swing-arm		
SACHS shock / 132 mm (5.2 in.)	SACHS® Big-Bore shocks / 129 mm (5.1 in.)	SACHS Shock with self-leveling air preload adjustment / 5.2 in. (132 mm)
270 mm discs with Brembo® 4-piston fixed calipers		
270 mm disc, 1-piston floating caliper with integrated parking brake		
Electrically actuated		
XPS Roadster - 165/55 R15 MC 69H		
XPS Roadster - 225/50 R15 MC 84H		
10-spoke, Deep Black, machined and tinted, 381 x 127 mm (15 x 5 in.)	10-spoke, Deep Black, 381 x 127 mm (15 x 5 in.)	10-spoke, Deep Black, 381 x 127 mm (15 x 5 in.)
6-spoke, 381 mm x 178 mm (15 x 7 in.)	6-spoke, 15 x 7 in. (381 mm x 178 mm)	6-spoke, 381 mm x 178 mm (15 x 7 in.)
2	2	2
199 kg (439 lb)	199 kg (439 lb)	199 kg (439 lb)
24.4 L (6.5 gal)	79.5 L (21 gal)	139.5 L (36.8 gal)
27 L (7.1 gal)	27 L (7.1 gal)	27 L (7.1 gal)
Premium unleaded		
2,642 x 1,497 x 1,099 mm (104 x 58.9 x 43.3 in.)	2,596 x 1,497 x 1,241 mm (102.2 x 58.9 x 48.9 in.)	2,820 x 1,497 x 1,241 mm (111.0 x 58.9 x 48.9 in.)
1,709 mm (67.3 in.)	1,709 mm (67.3 in.)	1,709 mm (67.3 in.)
675 mm (26.6 in.)	675 mm (26.6 in.)	675 mm (26.6 in.)
115 mm (4.5 in.)	115 mm (4.5 in.)	115 mm (4.5 in.)
408 kg (899 lb)	430 kg (948 lb)	448 kg (988 lb)
10.25 in. touchscreen display with BRP Connect and Apple CarPlay		
Speedometer, tachometer, odometer, trip and hour meters, fuel consumption avg, gear position, ECO mode, Sport mode, temperature, engine lights, electronic fuel gauge, clock and more.	Speedometer, tachometer, odometer, trip and hour meters, fuel consumption avg, gear position, ECO mode smart assist, temperature, engine lights, electronic fuel gauge, clock and more.	Speedometer, tachometer, odometer, trip and hour meters, fuel consumption avg, gear position, ECO mode smart assist, temperature, engine lights, electronic fuel gauge, clock and more
USB, Bluetooth**	BRP Audio 4-speaker sound system with radio, USB, Bluetooth†	BRP Audio Premium 6-speaker sound system with radio, USB, Bluetooth†
Stability Control System		
Traction Control System		
Anti-lock Braking System		
Dynamic Power Steering		
Digitally Encoded Security System (D.E.S.S.™)		
Hill Hold Control		
LED headlights, Front fender with integrated LED lights, Cruise control, Handlebar control module, Sport mode, Can-Am Red color frame, Sport silencer	LED headlights, Front fender with integrated LED lights, Cruise control, Handlebar control module, Sport windshield, Glove box with USB (1 gal / 3.5 l), Integrated hard-side luggage	LED headlights, Front fender with integrated LED lights, Cruise control, Handlebar control module, Sport windshield, Glove box with USB (3.5 L. / 1 gal), Integrated hard-side luggage, Top case with integrated passenger backrest (22 L. / 5.8 gal), Driver and passenger heated grip, Driver and passenger footboards

		SPYDER F3 LTD SPECIAL SERIES	SPYDER RT LIMITED	SPYDER RT SEA-TO-SKY
				
Color Options		British Green Metallic	Hyper Silver Metallic* Carbon Black* Mineral Blue Satin*	Dusk Metallic
ENGINE	Type	Rotax® 1330 ACE™ in-line 3 cylinders, liquid-cooled with electronic fuel injection and electronic throttle control	Rotax® 1330 ACE™ in-line 3 cylinders, liquid-cooled with electronic fuel injection and electronic throttle control	
	Bore & stroke	3.31 x 3.14 in. (84 x 80 mm)	3.31 x 3.14 in. (84 x 80 mm)	
	Power	115 hp (85.8 kW) @ 7250 RPM	115 hp (85.8 kW) @ 7250 RPM	
	Torque	96 lb-ft. (130.1 Nm) @ 5000 RPM	96 lb-ft. (130.1 Nm) @ 5000 RPM	
TRANSMISSION	Type	Semi-automatic with reverse function	Semi-automatic with reverse function	
	Gears	6-speed	6-speed	
CHASSIS	Front suspension	Double A-arms with anti-roll bar	Double A-arms with anti-roll bar	
	Front shock type/travel	SACHS® Big-Bore shocks / 5.1 in. (129 mm)	SACHS® Big-Bore shocks / 6.9 in. (174 mm)	
	Rear suspension	Swing-arm	Swing-arm	
	Rear shock type/travel	SACHS Shock with self-leveling air preload adjustment / 5.2 in. (132 mm)	SACHS® Shock with self-leveling air preload adjustment / 6 in. (152 mm)	
	Front brakes	270 mm discs with Brembo® 4-piston fixed calipers	270 mm discs with Brembo® 4-piston fixed calipers	
	Rear brake	270 mm disc, 1-piston floating caliper with integrated parking brake	270 mm disc, 1-piston floating caliper with integrated parking brake	
	Parking brake	Electrically actuated	Electrically actuated	
	Front tires	XPS Roadster - 165/55 R15 MC 69H	XPS Roadster - K165/55 R15 69H (NA) XPS Roadster - 165/55 R15 MC 69H (INT)	
	Rear tire	XPS Roadster - 225/50 R15 MC 84H	XPS Roadster - K225/50 R15 84H (NA) XPS Roadster - 225/50 R15 MC 84H (INT)	
	Aluminum front rims	16-spoke, Carbon Black, 381 x 127 mm (15 x 5 in.)	6-spoke, 15 x 5 in. (381 x 127 mm)	381 x 127 mm (16-spoke, Moka, 15 x 5 in.)
Aluminum rear rim	6-spoke, 381 mm x 178 mm (15 x 7 in.)	6-spoke, 15 x 7 in. (381 mm x 178 mm)		
CAPACITY	Rider capacity	2	2	
	Maximum vehicle load	199 kg (439 lb)	494 lb (224 kg)	
	Storage capacity	(139,5 L (36.8 gal))	47 gal (177 L)	
	Fuel capacity	27 L (7.1 gal)	7 gal (26,5 L)	
	Fuel type	Premium unleaded	Premium unleaded	
DIMENSIONS	L x W x H	2,820 x 1,497 x 1,241 mm (111.0 x 58.9 x 48.9 in.)	111.5 x 61.2 x 57.6 in. (2,833 x 1,554 x 1,464 mm)	
	Wheelbase	1,709 mm (67.3 in.)	67.5 in. (1,714 mm)	
	Seat height	675 mm (26.6 in.)	29.7 in. (755 mm)	
	Ground clearance	115 mm (4.5 in.)	4.5 in. (115 mm)	
	Dry weight	448 kg (988 lb)	1,021 lb (464 kg)	
INSTRUMENTATION	Type	10.25 in. touchscreen display with BRP Connect and Apple CarPlay	10.25 in. touchscreen display with BRP Connect and Apple CarPlay	
	Main functions	Speedometer, tachometer, odometer, trip and hour meters, fuel consumption avg, gear position, ECO mode smart assist, temperature, engine lights, electronic fuel gauge, clock and more	Speedometer, tachometer, odometer, trip and hour meters, fuel consumption avg, gear position, ECO mode smart assist, temperature, engine lights, electronic fuel gauge, clock, and more.	
	Audio System	BRP Audio Premium 6-speaker sound system with radio, USB, Bluetooth†	BRP Audio Premium 6-speaker sound system with radio, USB, Bluetooth†	
SAFETY & SECURITY	SCS	Stability Control System	Stability Control System	
	TCS	Traction Control System	Traction Control System	
	ABS	Anti-lock Braking System	Anti-lock Braking System	
	DPS™	Dynamic Power Steering	Dynamic Power Steering	
	Anti-theft system	Digitally Encoded Security System (D.E.S.S.™)	Digitally Encoded Security System (D.E.S.S.™)	
	HHC	Hill Hold Control	Hill Hold Control	
FEATURES		LED headlights, Front fender with integrated LED lights, Cruise control, Handlebar control module, Sport windshield, Glove box with USB (3.5 L / 1 gal), Integrated hard-side luggage, Top case with integrated passenger backrest (22 L / 5.8 gal), Driver and passenger heated grip, Driver and passenger footboards, Short reach handlebar, Top case rack, Adjustable driver backrest, Comfort seat	Premium LED headlights, Driver Touring Floorboards, Adjustable passenger footboards, Handlebar control module, Ultra comfortable seat with lumbar support, Glove box with USB (0.36 gal), Cruise control, Integrated hard-side luggage, Adjustable electric windshield with memory, LinQ compatible, Fixed side wind deflectors, Driver and passenger heated grip, Driver and passenger heated seat, Top case with integrated passenger backrest (22 l / 5,8 gal)	Premium LED headlights, Driver Touring Floorboards, Adjustable passenger footboards, Handlebar control module, Ultra comfortable seat with lumbar support, Glove box with USB (1.36 L / 0.36 gal), Cruise control, Integrated hard-side luggage, Adjustable electric windshield with memory, LinQ compatible, Adjustable side wind deflectors, Driver and passenger heated seat, Driver and passenger heated seat, Top case with integrated passenger backrest (22 L / 5,8 gal), Adaptive foam seat with Sea-to-Sky embroidery, Unique Sea-to-sky badges and colors, Colored rear panel, Adjustable driver backrest
			* Parts and trims	

CANYON		CANYON XT		CANYON REDROCK	
					
Sterling Silver Satin		Sterling Silver Satin		Moss Green Satin	
Rotax® 1330 ACE™ in-line 3 cylinders, liquid-cooled with electronic fuel injection and electronic throttle control					
84 x 80 mm (3.31 x 3.14 in.)					
115 hp (85.8 kW) @ 7250 RPM					
96 lb-ft. (130.1 Nm) @ 5000 RPM					
Semi-automatic with reverse function					
6-speed					
Double A-arms with anti-roll bar					
SACHS® Big-Bore shocks / 260 mm (10.2 in.)			SACHS® Big-Bore shocks / 260 mm (10.2 in.)		
Swing Arm					
SACHS shock / 235 mm (9.2 in.)		SACHS Shock with self-leveling air preload adjustment / 235 mm (9.2 in.)		KYB Smart Shox with self-leveling air preload adjustment / 9.2 in. (235 mm)	
270 mm discs with Brembo®, 4-piston fixed caliper					
270 mm disc, 1-piston floating caliper with integrated parking brake					
Electrically actuated					
XPS Adventure - 155/65 R16 MC 72H					
XPS Adventure - 225/50 R15 MC 84H					
12-spoke, Carbon Black , 406 x 127 mm (16 x 5 in.)			12-spoke, Carbon Black / Alloy Orange, 406 x 127 mm (16 x 5 in.)		
6-spoke, 381 mm x 178 mm (15 x 7 in.)					
2					
298 kg (656 lbs)		280 kg (617 lb)			
0,6 L (Glove Box)		120,6 L (31.86 gal)			
27 L (7.1 gal)					
Premium unleaded					
2489 x 1581 x 1500 mm (98 x 62.2 x 59 in.)			2547 x 1581 x 1500 mm (100.3 x 62.2 x 59 in.)		
1718 mm (67.6 in.)					
843 mm (33.2 in.)					
169 mm (6.65 in.)					
452 kg (996 lbs)		470 kg (1036 lbs)			
10.25 in. touchscreen display with BRP Connect and Apple CarPlay					
Speedometer, tachometer, odometer, trip and hour meters, fuel consumption avg, gear position, Drive mode, temperature, engine lights, electronic fuel gauge, clock and more.			Speedometer, tachometer, odometer, trip and hour meters, fuel consumption avg, gear position, Drive mode, Custom Mode, temperature, engine lights, electronic fuel gauge, clock and more.		
USB, Bluetooth ¹					
Stability Control System					
Traction Control System					
Anti-lock Braking System					
Dynamic Power Steering					
Digitally Encoded Security System (D.E.S.S.™)					
Hill Hold Control					
Model Features: LED headlights, Metal radiator grille, Adjustable windshield, Glove box with USB cable, Hand guards, Integrated LinQ attachment points, Cruise control, Enduro anti-slip pegs, Adjustable Drive modes, Belt protector, 143 mm (5.6 in.) Handlebar riser		Model Features: LED headlights, Metal radiator grille, Adjustable windshield, Glove box with USB cable, Hand guards, Integrated LinQ attachment points, Cruise control, Enduro anti-slip pegs, Adjustable Drive modes, Belt protector, 143 mm (5.6 in.) Handlebar riser, Aluminum top & side case, Driver and passenger heated grips, Passenger backrest, Self-leveling rear air suspension, Comfort pegs, Front Skid plate,, Comfort seat Package Features: Aluminum top and side cases, Adventure ready 3-wheel vehicle, Impressive stability and enhanced rear suspension, Comfort and convenience for two, LinQ integration for easy accessorization		Model Features: LED headlights, Metal radiator grille, Adjustable windshield, Glove box with USB cable, Hand guards, Integrated LinQ attachment points, Cruise control, Enduro anti-slip pegs, Adjustable Drive modes, Belt protector, 143 mm (5.6 in.) Handlebar riser, Custom drive modes, Aluminium top & side case, Driver and passenger heated grips, Passenger backrest, Self-leveling rear air suspension, Comfort pegs, Front Skid plate, Comfort seat, Back-up camera, Smart-Shox Semi-activ suspension Package Features: Premium aluminum top and side cases, Enhanced visibility with back-up camera, Top of the line semi-active suspension: Smart-Shox, Comfort and convenience for two, LinQ integration for easy accessorization	



ACCESSORIES

ACCESSORIES

Panels and Hoods	36
Handlebars	37
Brake and Shifter Linkages	38
Seats and Backrests	38
Windshields and Wind Protection	44
Cargo and Storage	47
Footboards	58
Idler Pulley	58
Lights and Electrical Accessories	59
Wheels and Fenders	63
Shocks	64
Silencers	64
Custom Accessories	65
Ride Protection	68
Covers	71

PANELS AND HOODS

PANELS

Classic Panels

All Ryker models

- **219400803** • Intense Black Gloss finish
- **219400804** • Adrenaline Red Gloss finish
- **219400928** • Yellow Shock Gloss finish



- An efficient and practical customization option.
- Road-ready and rugged, and a snap to install.
- Matches Classic Hood Accent.
- Remarkably simple to install or remove.

Epic Panels

All Ryker models

- **219400805** • Immortal White High-gloss finish
- **219400923** • Liquid Steel High-Gloss finish



- Optimized premium customization for a look that suits the ride.
- Designed to be easy-on, easy-off, and easy to love!
- Total flexibility with a perfect fit and vehicle match.
- Complements the Epic Hood.
- Painted color for exceptional luminosity and a premium look.

Exclusive Panel Kit

All Ryker models



■ **219401281** • Atlantis Gold

- Stand out and stand up for originality.
- Innovative easy installation.
- Engineered to fit right and fit tight.
- As durable as they are attractive.
- Exclusive Panel Kit includes hood accent.
- Exclusive Panel Kit hood accent incompatible with the LED Auxiliary Light (219401075).

- **219401133** • Heritage White IV
- **219401134** • Sonic Silver
- **219400988** • Heritage Yellow
- **219401002** • Sand Storm
- **219401157** • Lemon Twist
- **219401246** • Goblin Green
- **219401247** • Diablo Red
- **219401248** • Purple Galaxy
- **219400943** • Racer Red
- **219401015** • Liquid Titan
- **219401003** • Mint Freeze
- **219400987** • Liquid Gold
- **219400989** • Galactic Blue
- **219401156** • Icepop Blue
- NEW**
- **219401278** • Urban Blue
- **219401279** • Cyber Orange
- **219401280** • Moka Plaid
- **219401281** • Atlantis Gold

HOODS

Classic Hood Accent

All Ryker models

- **219400873** • Intense Black Gloss finish
- **219400874** • Adrenaline Red Gloss finish
- **219400875** • Yellow Shock Gloss finish



- Add a little oomph up front!
- Installs over stock hood in minutes.
- Built to last.
- Matches Classic Panels.
- Incompatible with the LED Auxiliary Light (219401075).

Epic Hood

All Ryker except Rally MY22 and up

- **219400876** • Immortal White High-Gloss finish
- **219400877** • Carbon Black Satin finish



- Distinctive hood-styling enhancement.
- Easily installs and removes in minutes.
- Matches Epic Panels.
- Painted color for exceptional luminosity and a premium look.

HANDLEBARS

Sport Handlebar

All Ryker models

219400813



- Performance-focused straight handlebar design.
- Ideal for the more aggressive rider.
- Reduces the gap between the rider and the handlebar by 1.92 inches.

Cross-Style Handlebar

All Ryker models

219400847



- Optimizes ergonomics for superior comfort, confidence, control and endurance.
- Reduces the gap between the rider and the handlebar by 1.59 inches.

Sport Grips

All Ryker models

■ **219400810** • Black
■ **219400919** • Adrenaline Red



- Improve grip for a better, more confident ride.
- Comfortable ergonomic texture.
- Deliver exceptional comfort on longer journeys.
- Sold in pairs.

Short Reach Handlebar

Spyder F3 2023 and prior,
Spyder RT 2020-2023

219400909

Spyder F3 2024 & up
Spyder RT 2024 & up

219401268



- Part of the UFit System.
- Perfect for shorter riders.

Long Reach Handlebar

Spyder F3 2023 and prior,
Spyder RT 2020-2023

219400910

Spyder F3 2024 & up
Spyder RT 2024 & up

219401269



- Part of the UFit System.
- The longer reach causes the torso to lean forward, bringing the riding position closer to the console.
- Perfect for taller riders.

Adjustable Handlebar

Spyder RT 2020-2023

219401046



- This handlebar adjusts by up to 2" for unmatched ergonomics.
- Adjustment is a snap: just flip the lever—no tools required.
- Made of anodized black aluminum for sleek durability.

NEW Fixed Riser - 6 in. (155 mm)

Canyon

219401211



- Handlebar extension kit to fit all riding styles.
- Accomodate different ergonomics.
- Easy installation that replace the stock riser.

BRAKE AND SHIFTER LINKAGES

Brake and Shifter Linkages

All F3 SE6 models

-2 • Position 1 • **219400561**
 -1 • Position 2 • **219400563**
 +1 • Position 4 • **219400566**
 +2 • Position 5 • **219400571**



- Part of the UFit System.
- Find the best driving position for you.
- Replace stock linkage (Position 3) to set pegs to different positions.

SEATS AND BACKRESTS

Solo Driver Comfort Seat

All Ryker models

219400962



- Two-tone polyurethane skin.
- Fully waterproof, it seats the driver an inch higher while being both two inches wider and longer, resulting in added legroom.
- Incompatible with the MAX Mount (219401169) and Rear Spoiler (219400869, 219400870, 219400871).
- Additional parts required for Ryker Rally—see instruction sheet.

Driver Comfort Seat

All Ryker models

219401254



- Cut-and-sew upholstery over padding for extra driver comfort.
- Wider and higher than stock seat.

Passenger Comfort Seat

All Ryker models

219401104
219400750



219401104

- Cut-and-sew upholstery over generous padding for added comfort.
- Wider and longer than the Passenger Seat (219400842).
- Complete kit includes handles and retractable pegs.
- The MAX Mount (219401169) is required for installation.
- Complements the Driver Comfort Seat (219401254).
- Passenger Comfort Seat (219401104) is designed to match the Ryker Sport style.



219400750

Passenger Seat

All Ryker models

219400842

- Designed to transform a 1-up to a 2-up configuration in minutes.
- Complete kit includes handles and retractable pegs.
- Pegs allow VSS passenger calibration when flipped out.
- Same material as stock seat.
- The MAX Mount (219401169) is required for installation.

Foldable Passenger Backrest

All Ryker models

219400843

- Cast-aluminum construction for added strength.
- Mid-lumbar support offers extra passenger comfort.
- Conveniently folds away providing better aesthetics when not in use.
- Passenger Seat or Passenger Comfort Seat required for installation.

Passenger Short Rail

All Ryker models

219400801

- Enhances essential lower-lumbar support.
- Installs in fixed position in minutes.
- Passenger Seat or Passenger Comfort Seat required for installation.

1-Up Driver Backrest

All Ryker models

219400960

- Can be installed or removed in an instant.
- Designed to enhance essential lumbar support.
- MAX Mount (219401169) is required for installation.
- Compatible with LinQ Top Case (219400764).
- Incompatible with Ryker LinQ Rack, Passenger Seat, Passenger Comfort Seat.

Driver Backrest

Ryker (except Rally models)

219401164

- New flexible plastic construction.
- Sleek design providing extra back protection.
- Can be used with or without MAX Mount (solo configuration or with a passenger).
- Adjustable tilt for optimal comfort.

MAX Mount

All Ryker models

219401169



- Road-rugged one-piece cast-aluminum construction that's easy to install and remove.
- Compatible with LinQ Top Case (219400764).
- Required for the installation of Passenger Seat, Passenger Comfort Seat, LinQ Top Case, or Ryker LinQ Rack.
- Stock equipment on Ryker Rally and Ryker Sport.

MAX Mount Trim

All Ryker models

219400939



- Stylish way to round out the appearance when no Passenger Seat or Passenger Comfort Seat is installed.
- Robust injection-molded polypropylene construction.
- Blends in perfectly with body styling and vehicle finish.
- The MAX Mount (219401169) is required for installation.
- Stock equipment on Ryker Rally and Ryker Sport.

2-Up Conversion Kit

(Not illustrated)

2019 and up F3 Base models

219400975

- Complete passenger kit to allow 2-up riding on 2019 and up F3 base.
- Includes passenger seat, pegs and handles.

Detachable Driver Backrest

All Spyder F3 models

219400498



- Generous width and height for superior lumbar support.
- Installs and removes in minutes.
- Tilt adjustable.
- Fits on production, Cannonball, Vinyl Coast-to-Coast and Leather Coast-to-Coast seats.
- Anti-theft feature.

Detachable Passenger Backrest

Spyder F3-S, F3-T

219401180



- Generous width and height for superior lumbar support.
- Initial installation in minutes, toolless removal in seconds.
- Anti-theft feature.
- Fits on production, Cannonball, Vinyl Coast-to-Coast and Leather Coast-to-Coast seats.
- Invisible mounting system unrecognizable when not installed.

Adjustable Passenger Backrest

Spyder F3-S, F3-T

219400794



- Dual axis adjustments for the backrest and cushion enable you to dial in comfort and add up to 2" (50 mm) more passenger room.

Passenger Hand Deflectors

Spyder F3, Spyder RT
2020 and up

219401043



- Semi-rigid deflectors, which clip onto the Spyder F3 and Spyder RT passenger handles.
- Installation in 2 minutes.
- Easy to install and uninstall.

Comfort Seat

Spyder RT 2020 and up

219400971



- Extra padding in all the right places in addition to a memory foam layer gives us every reason to call it our Comfort Seat.
- Smartly styled, its elevated passenger seat gives anyone coming along for the ride a scenic way to enjoy the open road.

Heated Comfort Seat

Spyder RT 2020 and up

219400972



- All the features of the much-loved Comfort Seat with integrated heating.
- Unit complete with individual dual-intensity driver and passenger controls for customized warmth when the weather's cool but the ride is still hot.

Heated Driver Seat

Spyder RT 2020 and up

219401044



- With an exterior identical in every way to our quality stock seat, our Heated Driver Seat comes with the added perk of integrated heating that's designed to keep you warm and comfortable when temperatures start to dip.
- Stock equipment on the RT Limited.

Heated Passenger Seat

Spyder RT 2020 and up

219401045



- Our Heated Passenger Seat takes comfort to a new level with integrated heating for absolute warmth on those days the call of the open road is stronger than the thought of riding it in the cold.
- Stock equipment on the RT Limited.

Comfort Seat

All Spyder RT models
2019 and prior

219400457



- Ultra comfortable with lumbar support.
- Roomier for driver, improves comfort during long rides.
- Driver backrest ready.
- Perfect for taller riders.

Adjustable Driver Backrest

Spyder RT 2014 - 2019, RT
2013 and prior
with 2014 and up
production seats

219400679

Fit with Comfort Seat
219400457
or Heated Comfort Seat
219400398

219400689



- Tilt adjustment to suit your riding style.
- Folds forward for easy passenger seat access.

For production seats (219400679)

- Unique plug-and-go design installs in seconds and works with all standard Spyder RT driver seats with no modification.

For Comfort Seats (219400689)

- Unique plug-and-go design installs in seconds and works with Spyder RT driver Comfort Seats with no modification.

Adjustable Driver Backrest

Spyder RT 2020 and up

219400957



- Offering comfort for long distance or short hops, our tilt-adjustable Driver Backrest folds down and out of the way for easier vehicle access.
- Its slim profile design allows for extra passenger room behind.
- Plus, it's lockable, so it'll always be there when you need it.
- Fits Comfort Seat (219400971), Heated Comfort Seat (219400972) and Heated Driver Seat (219401044).

LinQ Passenger Backrest

Spyder RT 2020 and up

219401130



- Installable quickly and easily onto the LinQ Rack, the Passenger Backrest is an excellent way to let your 2-up partner enjoy the rush of the ride in absolute comfort.
- Fully compatible with the optional Passenger Armrests.
- The RT LinQ Rack is required for installation.

Passenger Armrests

All Spyder RT models
2019 and prior

219400839



- The ultimate in long- or short-distance passenger comfort.
- Pivot up and out of the way for easy passenger access and exit.
- Styled to ensure an absolute match to your Can-Am Spyder.
- Allow easy access to passenger handles for added safety.

Passenger Armrests

Spyder RT 2020 and up

219401181



- Local or long-distance, these horizontally and vertically adjustable Passenger Armrests assure optimal comfort for those keeping you company for the ride.
- A snap to install, they pivot outwards to allow easy vehicle access.
- Incompatible with RT Rear Panel.

Passenger Armrests

All Spyder F3 models

219400726



- Adjust upwards, downwards, forwards, backwards, and outwards.
- Arm height provides up to 0.78" (20 mm) vertical adjustment.
- Complete with grip for added passenger security.
- Top Case not required for installation or use, but recommended.
- Passenger Backrest also recommended for installation.

NEW Driver Backrest

Canyon

219401176



- Made of a super high density polyurethane foam overmolded on an aluminum base.
- Covered by a soft black vinyl.
- Angle adjustment for a more comfortable fit.
- Folds forward for easy passenger seat access.
- No tools required for the installation.

NEW Passenger Backrest

Canyon

219401194



- Made of a super high density polyurethane foam overmolded on an aluminum base.
- Covered by a soft black vinyl.
- The Top case (219401224) is required to install the passenger backrest.
- Helps passenger maintain healthy, ergonomic posture.
- Include drilling template to ease installation.
- Screws come with rubber sealing rings to ensure waterproofness.

NEW Heated Premium Seat

Canyon

219401177



- Enhancing comfort with Cut and Sew Upholstery with generous padding.
- Dual range Hi/Low heat setting.
- Our Heated Premium Seat for driver and passenger takes comfort to a new level with integrated heating for absolute warmth on those days the call of the open road is stronger than the thought of riding it in the cold.

WINDSHIELDS AND WIND PROTECTION

Adjustable Sport Windshield

All Ryker models

219401023



- Enjoy extra protection from upper-body wind blast.
- Provides added comfort and enhanced aerodynamic slip.
- Innovative flip-lever design allows for easy adjustments in infinite positions over 3" stroke.
- Complete with integrated lower deflector and matching aluminum support.

Adventure Adjustable Windshield

All Ryker models

219401032



- Be ready for any adventure with a windshield that's 150% larger than the Adjustable Sport Windshield (219401023).
- Provides added protection from blasts of wind to the upper body.
- Its enhanced comfort and aerodynamic slip, innovative flip-lever design and built-in lower deflector guarantee a riding experience like no other.

Adventure Adjustable Windshield

(screen only)

All Ryker models

219401030



- Screen of the Adventure Adjustable Windshield (219401032).
- No bracket.

Hand guard Deflectors

All Ryker models

219400894



- Offer additional hand protection in all road conditions.
- Engineered for impact resistance and durability.
- Added comfort means added endurance.
- Require Aluminum Hand guards (219400998) for installation.

Aluminum Hand guards

All Ryker models

219400998



- Extra protection for the hands.
- Add an exciting adventure look.
- Attractive wrap-around aluminum construction.
- Required for installation of Hand guard Deflectors (219400894) and Hand guard Accent Lighting (219400820).
- Stock equipment on Rally Edition model.

Blue Ridge Windshield

Spyder F3, F3-S

219401264



- Made of clear 4.5 mm polycarbonate.
- Comes complete with supports and hardware.
- Dimensions: 21.25" (54 cm) high.

Route 129 Windshield

Spyder F3, F3-S

219401263



- Sport windshield.
- Made of 4.5 mm polycarbonate.
- Provides lower body protection.
- Comes complete with supports and hardware.
- Dimensions: 15.5" (39 cm) high.

Tall Boy Windshield

Spyder F3-T, F3 Limited

219400596



- Mid-height windshield.
- Scratch- and UV-resistant hardcoat on 5 mm polycarbonate shield.
- Windshield supports included.
- Dimensions: 20.25" (51.5 cm) high.

Gauge Spoiler

Spyder F3, F3-S

■ **219401299** • Smoke



- Enhances the sporty look of the Can-Am Spyder F3.
- Made of injected tinted polycarbonate.

Adjustable Touring Vented Windshield

Spyder RT 2020 and up

219401267



- Perfect for taller riders but designed for anyone who enjoys riding with less wind and more fun!
- Robust 4.5 mm thick scratch-resistant crystal-clear polycarbonate stands 3 full inches higher than our stock windshield, pushing the wind vortex up and over riders' heads creating considerably less buffeting for an appreciably quieter ride.
- Convenient integrated front vents offer variable air flow control.
- Tinted with 75% light transmission.
- Dimensions: 27 inches (68 cm) high.

Adjustable Sport Windshield

Spyder RT 2020 and up

219400956



- Give your Can-Am Spyder a look that lets everyone know you mean business!
- Low-profile, road-rugged polycarbonate-build sport windshield, as ready for the road as it is for excitement.
- Sporty look, sporty feel, unforgettable ride.
- Tinted with 75% light transmission.
- Dimensions: 14 inches (35 cm) high.

Adjustable Side Wind Deflectors – Lower

Spyder RT 2020 and up

219401088



- Regulate driver and passenger lower-body airflow.
- Change to closed, open or parallel position for optimal comfort.
- Simple, tool-free adjustment so you can spend more time riding.

Adjustable Side Wind Deflectors – Upper

Spyder RT 2020 and up

219401040



- Regulate driver and passenger upper-body airflow.
- Change to closed, open or parallel position for optimal comfort.
- Simple, tool-free adjustment so you can spend more time riding.

NEW High Windshield

Canyon

219401174



- Engineered shape and air passage to optimize wind protection, comfort and fuel efficiency.
- Hardcoated clear polycarbonate.
- 4.5mm thick and 20 in.(508 mm) Height.

NEW Sport Windshield

Canyon

219401175



- Relieved wind pressure from the chest area for a comfortable ride.
- Hardcoated clear polycarbonate.
- 4.5mm thick and 11 in.(279 mm) Height.

NEW Hand guard Deflectors

Canyon

219401186



- Delivers additional hand protection from the elements.
- Extension in smoked 3 mm polycarbonate.
- Fits on the original handguards.

CARGO AND STORAGE

LinQ Urban Bag

Ryker, Spyder RT 2020 and up

219401026



- LinQ Urban Bag (16").
- Multi-platform LinQ fit.
- Volume up to 40 liters.
- Water-resistant outer shell.
- Heavy-duty construction with high-quality zippers.
- Reversible integrated flap with water-resistant storage pockets.
- Easy-access large roll-top opening (glove-friendly).
- Inside-vehicle key-holder fastener.

Inner liner:

- Waterproof removable liner.
- Integrated storage pocket
- Integrated padded laptop pocket.

Backpack option:

- Adjustable and removable shoulder system to better fit man and woman riders.
- Ergonomic and comfortable back pads.
- Lightweight shoulder system design.

Ryker LinQ Plate

All Ryker models

219400965



- Designed to accommodate a wide range of BRP LinQ 16" accessories.
- Mounting system allows installation quickly and easily onto the MAX Mount.
- The MAX Mount (219401169) is required for installation.

Ryker LinQ Rack

All Ryker models

219401103



- Add-on to the LinQ Plate for more cargo options.
- Comes with a cargo net.
- Bungee cord-friendly.
- Requires LinQ Plate to be installed.

LinQ Tool Holders

All Ryker models

715007358



- Innovative swivel latch allows it to securely grip objects such as tools or fishing rods in a variety of positions.
- Sold in pairs.
- The Ryker LinQ Rack (219400965) is required for installation.

LinQ Thermal Box

All Ryker and Spyder RT 2020 and up

219400964



- Versatile, road-friendly, rotomolding-build LinQ Thermal Box designed to keep things hot or cold, and always ready for when you need them.
- Its expansive 4.2 gal (16 L) capacity lets you cater to any size hunger or thirst whatever the length of the ride.
- The Ryker LinQ Rack or RT LinQ Rack is required for installation.

LinQ Modular Box (10 L)

Ryker, Spyder RT 2020 and up

715005494



- Modular LinQ cargo boxes with 10 L (2.6 gal) capacity.
- Allows stacking of other modular boxes to always have the right gear accessible.
- The Ryker LinQ Rack or RT LinQ Rack is required for installation.

Thermal Insert for LinQ Modular Box (10 L)

Ryker, Spyder RT 2020 and up

219401110



- Insulated liner.
- Fits very well in the LinQ Modular Box (10 L).
- Can contain five 473 ml cans or six 355 ml cans.

LinQ Sport Bag

All Ryker models and Spyder RT 2020 and up

860202447



- Our 4.5 gal (17 L) LinQ Sport Bag holds everything in while keeping the weather out.
- The perfect place to keep wallets, water bottles, smartphones and jackets safe and secure.
- Constructed with a sturdy rigid bottom with semi-rigid top.
- The Ryker LinQ Rack or RT LinQ Rack is required for installation.

LinQ Roll-Top Bag

All Ryker models and Spyder RT 2020 and up

715008110



- LinQ Roll-Top Bag offers 10.6 gal (40 L) of fully waterproof adjustable storage for your essentials.
- Its roll-top design secures your gear snugly, while a heavy-duty rigid plastic base and foam-lined bottom offer additional protection for the long haul.
- An integrated handle allows for easy transportation on or off the vehicle.
- The Ryker LinQ Rack or RT LinQ Rack is required for installation.

LinQ SR21 Tunnel Bag

All Ryker models and Spyder RT 2020 and up

860202449



- Semi-rigid expandable LinQ Tunnel Bag offers a roomy 5.5 gal (21 L) capacity.
- Convenient, quick and easy toolless LinQ installation and removal.
- The Ryker LinQ Rack or RT LinQ Rack is required for installation.

LinQ Semi-rigid Bag

All Ryker models and Spyder RT 2020 and up

219401039



- Offers 10.6 gal (40 L) of cargo space for fully loaded adventures.
- Semi-rigid design and built-in rain cover keep your stuff safe in any condition.
- The yellow interior helps you find what you're looking for in seconds.
- Removable mesh organizer and carry-on pouch for increased customization.
- The Ryker LinQ Rack or RT LinQ Rack is required for installation.
- Not compatible with LinQ Lock (860201968).

LinQ Top Case (16 L)

All Ryker models

219400764



- 4.2 gal (16 L) of rugged, securely mounted roll-top weatherproof storage.
- Quick and easy toolless LinQ system—effortless removal and installation.
- The MAX Mount (219401169) is required for installation.
- Incompatible with Passenger Seat or Passenger Comfort Seat.

NEW LinQ Top Case (36L)

All Ryker models

219401262



- Weatherproof top case.
- 36 Litres Capacity.
- Installs under the tail section / passenger seat.
- Requires MAX Mount SKU 219401169 on Standard model.
- Quick and easy toolless LinQ system removes as effortlessly as it installs.
- Fits all sizes of helmet.
- Possibility of installing a bright yellow inner liner designed expressly for the Top Case.
- Incompatible with Passenger Seat or Passenger Comfort Seat.
- Backrest cushion made from injected polyurethane foam covered with vinyl that can resist all riding conditions included.

NEW Top Case Inner Liner

All Ryker models

219401257



- Weather resistant.
- The yellow interior helps you find what you're looking for in seconds.
- Designed expressly for the LinQ Top Case.
- Interior and exterior pockets with zippers.
- Easily transportable with straps.
- Requires LinQ Top Case.

LinQ Lock

Ryker, Spyder RT 2020 and up

860201968

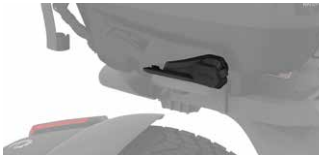

- Simple way to lock most LinQ accessories in place.
- Retrofits most LinQ accessories.
- A cover protects the lock from the elements.
- Not compatible with Tool Holder and LinQ 4.2 US Gal (16 L) Cooler.
- Pack of 1.
- Comes with 2 keys.

Tank Bag

All Ryker models

219400762



- Safely and securely stow away keys, wallet, ID and more (capacity: 0.75 gal/3 L).
- Integrated mobile-phone holder.
- Convenient easy-access storage at your fingertips.
- Secure magnetic holding system with extra safety buckles.

Front Storage Organizer

All Ryker models

219401112



- Foam liner that maximizes storage in your glove box.
- Pockets on each side of the liner and in the lid for better organization.

Helmet Bag

All Ryker models (except Ryker Rally 2022 and up)

219400765



- Integrated helmet storage solution.
- Allows locking of helmet onto driver seat.
- Anti-theft device for added peace of mind (padlock not included).
- Conveniently doubles as rain guard for seat.
- Helmet bag can also be mounted on Passenger Seat (219400842).
- Conveniently store in front bin.

SHAD⁺ Hard Saddlebag

All Ryker models

219400844



- Shock-resistant storage with enough room for a 2XL full-face helmet equipped with a communication system (capacity: 9.5 gal/36 L).
- Robust 3-point mount for added stability, security and peace of mind.
- Simple single-bag right-side installation.
- Saddlebag Rack (219400856) is required for installation.

Saddlebag Rack

All Ryker models

219400856



- Ultra-sturdy long-distance-durable aluminum construction.
- Required for installation of SHAD Hard Saddlebag (219400844).
- Integrated and clean look when SHAD Hard Saddlebag is not installed.

SHAD Saddlebag Liner

All Ryker models

219401074



- Designed expressly for SHAD Hard Saddlebag (219400844) to provide extra convenience.
- Includes integrated carrying handle and a shoulder strap.

SHAD Saddlebag Liner

Spyder F3, F3-S

219401073



- Designed expressly for SHAD Saddlebags (219400721) to provide extra convenience.
- Include integrated carrying handle and a shoulder strap.
- Sold in pairs.

SHAD Saddlebags for Can-Am

Spyder F3, F3-S

219400721



- Patented lightweight bike-specific design.
- 3-point mount.
- Waterproof, shock-resistant.
- 9.5 gal capacity (36 L).
- Enough room for a 2XL full face helmet equipped with a communication system.
- Unique Can-Am reflector.
- Required mounting support and hardware are sold separately (219400728 for North America, 219400727 for Europe).

SHAD Saddlebag F3 Rack

(Not illustrated)

Spyder F3, F3-S

219400728 • US

219400727 • Europe

- Custom rack specially designed for mounting SHAD Saddlebags (219400721).
- Integrated red reflectors (219400728) or amber reflectors (219400727) and necessary hardware for SHAD Saddlebags.

SHAD Waterproof Rear Bag

All Can-Am On-Road models

219401099



- Maximum, accessible protection for your belongings with a waterproof main compartment and glove-friendly zippers.
- Reflective features ensure optimal safety on the road.
- A multitude of pockets for versatility and made from durable, easy-to-clean material for practicality.

Deluxe Saddlebag Liners

Spyder F3-T, F3 Limited

219400606



- Complete your production saddlebags with Deluxe Saddlebag Liners.
- The easiest way to carry your items from your Can-Am Spyder saddlebag.
- Include integrated handle and shoulder strap.

Front Cargo Bag

All Spyder F3 models

219400631



- Easy way to organize and tote your items in the front cargo compartment.
- Slides in and out.
- Includes integrated handle and shoulder strap.

Top Case Rack

Spyder F3-T with Top Case, F3 Limited 2017 and up, RT 2020 and up with Top Case

219400743



- Allows for added external storage capacity when used with netting or bungee cords.
- Sturdy stamped-aluminum construction.
- Includes integrated anchor points.

RT Top Case

Spyder RT 2020 and up

219401011 • US

219401079 • Europe



- Consider the convenience of 46.7 gal (177 L) when it comes to carrying all your essentials on that unforgettable road trip.
- Our all-new Top Case adds 5.8 gal (22 L) of extra storage, but more than that, it expands practicality with a larger opening and it now fits 2 helmets!
- Plus it includes a dedicated USB port for device charging.
- Stock equipment on the RT Limited.
- The key barrel is sold separately.

RT Rear Panel

Spyder RT Limited 2020 and up

■ **219401076** • Asphalt Grey

■ **219401014** • Deep Marsala

■ **219401013** • Petrol Metallic

■ **219401166** • Carbon Black

■ **219401154** • Chalk Metallic



- The Top Rear Panel caps the area normally occupied by the Top Case when not in use, preserving the smooth lines and sporty appearance of your ride.
- Incompatible with Passenger Armrests (219400958).
- Stock equipment on the base model.

RT LinQ Rack

Spyder RT 2020 and up

219401145



- Enhance your Can-Am Spyder RT's flexibility with the convenient, incomparable RT LinQ Rack.
- Using a secured latch to hold a wide range of BRP LinQ 16" accessories, it's the ideal accessory multitasker.
- Installs in minutes without tools.
- Replaces the stock Top Case on RT Limited models.

Top Case Inner Bag

Fits in Top Case

219400748



- Maximizes top case volume.
- Complete with integrated handle and shoulder strap for convenient portability.

Semi-rigid Rear Side Cargo Travel Bags

All Spyder RT models

219400169



- Stylish premium travel bags specifically sized to fit in rear side cargo.
- Retractable handle and shoulder straps for carrying convenience.
- Integrated pull tabs for effortless removal from cargo cavity.
- Sold in pairs.

Soft Side Cargo Travel Bags

All Spyder RT models

219400172



- Soft travel bags that maximize Spyder RT rear side cargo space.
- Integrated handle for carrying convenience.
- Sold in pairs.

Integrated Helmet BagAll Spyder RT models
2019 and prior and all
Spyder F3 models**219400850**



- Truly integrated easy-to-use helmet storage solution.
- Sturdy water-resistant construction.
- Includes elastic straps for tying down helmet bag onto seat.
- Complete with anti-theft wire for added security.

Top Case MirrorAll Spyder RT models
2019 and prior**219400321**



- For rear top cargo cover.
- Folds open, locks up when not in use.
- Offers a small cargo space in the top case lid.

Semi-rigid Front Cargo Travel Bag

All Spyder RT models

219400167



- Rolling travel bag designed to maximize available front cargo space.
 - Can also double as airplane carry-on luggage.
-

NEW Aluminum Side Cases

Canyon

219401282



- High quality aluminum construction.
- 36 Litres capacity.
- Easy quick connect installation using integrated LinQ on the vehicle.
- No extra brackets required.
- Compatible with passenger seat.
- Sold in pair.

NEW Aluminum Top Case

Canyon

219401224



- All aluminum rugged construction premium top case.
- 48 Litres capacity.
- Easy quick connect installation.
- Lockable with a lock on the front (keys are provided with the vehicle).
- No extra brackets required.
- Compatible with passenger seat and Aluminum Side Cases (219401282).

NEW Inner Bag

Canyon

219401189



- Can be taken out of the cases as a normal bag.
- Easy to carry with a shoulder strap.
- Closes with a Zipper and have an extra zipped front pocket.
- Come with an expansion zipper that runs around the outside of the bag. Unzip it for more packing space.
- Compatible with Aluminum Top Case (219401224) and Aluminum Side Cases (219401282).

NEW LinQ Nano Tank Bag

Canyon

219401173



- Weatherproof tank bag.
- Safely and securely stow away keys, wallet, ID and more .
- Integrated mobile phone pocket with clear window inside the bag.
- Easy on/off with LinQ system.
- Uses the LinQ Nano mounting system already integrated on the vehicle for the installation.
- The yellow interior helps you find what you're looking for in seconds.

NEW LinQ 36" Adventure Plate

Canyon

219401183



- Enables the Canyon to carry certain LinQ 36" accessories.
- Strong and durable.
- Steel construction for rugged durability.
- Carry up to 75lbs of cargo.
- Easy and tool-less installation thanks to the LinQ System.
- Can be used as a solid surface to secure items with tie-downs or bungee cords.

NEW LinQ 2.6 US Gal (10 L) Modular Cargo Box

Canyon

715005494



- 2.6 US Gal (10 L) of hard-sided modular cargo capacity.
- Heavy duty construction with weather-resistant sealed lid.
- Stackable with an additional LinQ Modular Box (715005494, 715007112) or Roll-Top Bag for expanded storage.
- Capable of mounting in multiple LinQ attachment location for added convenience.
- Dimensions: 19" L x 12½" W x 5" H.
- Requires LinQ Base Installation Kit (295101009) to stack boxes or bag.
- Keep LinQ accessories safely secured on your vehicle with the LinQ lock (860201968).

NEW LinQ 5 US Gal (20 L) Modular Cargo Box

Canyon

715007112



- 5.2 US gal (20 L) of hard-sided modular storage capacity.
- Heavy duty construction with weather resistant sealed lid.
- Additional LinQ Modular Box (715005494) can be stacked on top for the ideal storage solution.
- Requires LinQ Base Installation Kit (295101009) to stack boxes or bag.
- Keep LinQ accessories safely secured on your vehicle with the LinQ lock (860201968).

NEW LinQ 7.8 US Gal (30 L) Modular Cargo Box

Canyon

715006830



- 7.8 US Gal (30 L) of hard-sided modular storage capacity.
- Heavy duty construction with weather resistant sealed lid.
- Keep LinQ accessories safely secured on your vehicle with the LinQ lock (860201968).

NEW LinQ Low Profile Box (63L)

Canyon

715007827



- Made of impact-resistant injected polypropylene and weatherproof.
- Storage capacity of 16.6 Gal (63 L).
- LinQ-mounted for efficient and secure storage.
- Locked in place with only a quarter turn.
- Easy to install, easy to remove using the LinQ system.
- LinQ 16" accessories can be installed on the cover to increase cargo capacity.
- Easily carried with the rigid handle.
- Anti-vibration system prevents the handle from moving while riding.
- Support feet at hinge level so the box can stand on its own.
- Compact design allows for maximum rear field of vision.
- Features a lock on the front of the box (two keys included).
- Requires LinQ Rack (219401183) for installation.

NEW LinQ 4.2 Gal (16 L) Cooler

Canyon

219400964



- All the benefits of LinQ - simple, fast and secure.
- Rotomolded construction for exceptional rigidity and durability.
- Premium-quality foam insulation for optimal ice retention.
- Utilizes LinQ mounting system.
- Easy one-second on/off tool-less system.
- Exterior dimensions: 13" L x 20" W x 10" H.
Interior dimensions: 9" L x 17" W x 7" H.
- Keep LinQ accessories safely secured on your vehicle with the LinQ lock (860201968).

NEW LinQ Sport Bag

Canyon

860202447



- All the benefits of LinQ - simple, fast and secure.
- 17 liter (4.5 US gallon) capacity.
- Thermoformed bag base in HDPE (High Density Polyethylene) providing rigidity and durability. Rigid bottom, semi-rigid top.
- Easy one-second on/off tool-less system.
- Keep LinQ accessories safely secured on your vehicle with the LinQ lock (860201968).

NEW Soft Storage Bag (70L)

Canyon

715007002



- Carry all your gear in a weatherproof bag thanks to this LINQ Soft Storage Bag.
- This bag comes with 3 compartments to protect things you pack from the weather elements.
- 18.5 gal (70L) designed to maximize space in front or rear of vehicle.
- Requires LinQ Rack (219401183) for installation.

NEW LinQ Fuel Caddy (4 gallons)

Canyon

860202246

- Quick, easy and secure installation with LinQ system.
- No-spill spout for easy use.
- 3.7 US gallon (14 liter) capacity.
- Keep LinQ accessories safely secured on your vehicle with the LinQ lock (860201968).
- Check local regulations regarding fuel transportation.

NEW LinQ Tool Kit

Canyon

715006829

- Included:
- Cutter pliers
 - Long-nose pliers
 - Locking pliers
 - Ratchet wrench 3/8" drive
 - 6" ratchet extension
 - Long-socket 19 mm 3/8" drive - 6pts
 - Socket 18 mm 3/8" drive
 - Long-socket 17 mm 3/8" drive - 6pts
 - Socket 15 mm 3/8" drive
 - Socket 13 mm 3/8" drive
 - Socket 10 mm 3/8" drive
 - Socket 8 mm 3/8" drive
 - Combination wrench 19 mm
 - Combination wrench 18 mm
 - Combination wrench 15 mm
 - Combination wrench 13 mm
 - Combination wrench 10 mm
 - Combination wrench 8 mm
 - Socket torx t40 3/8" drive
 - Socket torx t30 3/8" drive
 - Socket torx t20 3/8" drive
 - Breaker bar 3/8" drive Integrated CVT belt storage location (belt not included).
 - Keep LinQ accessories safely secured on your vehicle with the LinQ lock (860201968).

NEW LinQ Lite Action Camera Holder

Canyon

295101139

- LinQ lite attachment system for cameras.
- Provides great vantage points to capture photos and videos.
- Offers 360-angle positioning for perfect filming and taking photos.
- Designed to hold devices securely.
- Fast, easy attachment and removal.

NEW LinQ Lock

Canyon

860201968 • Pack of 1 with 2 keys**860202478** • Pack of 2 with 4 keys

- Simple way to securely lock most LinQ accessories.
- Lock cover protects lock from the elements. Corrosion resistant.
- Not compatible with LinQ Tool Holder, LinQ Working Light, LinQ 4.2 US Gal (16 L) Cooler, LinQ Retractable Ski Pylon and LinQ Box.

NEW One-Key System 3-Pack*(Not illustrated)*

Canyon

219401305

- Use a single key for your entire vehicle.
 - Lock your side cases and top case and you can use it even for refueling.
- This kit includes:
- 3 locks all using the same key (set of 2 keys).
 - The fuel door and the ignition switch.

FOOTBOARDS

Ryker Floorboards

Ryker

219401109



- Floorboards for better comfort.
- Help reduce vibrations.
- Replace footpegs.

Floorboard Risers

Spyder RT 2020 and up

219401163



- Designed for better comfort and accessibility for shorter riders.
- Increase the height of the floorboards by 5/8".
- Replace the stock floorboard rubber mats.
- The kit also includes a riser (shim) for the brake pedal pad.

Passenger Footboards

All Spyder F3 models

■ **219400901** • Carbon Black



- Replace stock pegs for additional comfort.
- Come with rubber pads and mounting hardware.

IDLER PULLEY

F3 Idler Pulley Service Kit

(Not illustrated)

All Spyder F3 models

219800431

- Enhances your comfort on the road by reducing vibrations generated by the belt.

RT Idler Pulley

Spyder RT 2020 and up

219800516



- Enhances your comfort on the road by reducing vibrations generated by the belt.
- Stock equipment on Spyder RT produced after January 4, 2021.

LIGHTS AND ELECTRICAL ACCESSORIES

Audio System

All Ryker models

219401033



- Plug-and-play audio system powered by MTX Audio.
- Bluetooth system.
- Easy pairing.
- 2 speakers and 4 tweeters.
- 110-decibel output.
- 50-watt RMS.
- 130-watt peak power.
- Windshield compatible with the Audio System (not included).
- Comes with a bracket for installing a windshield on top of your audio system.
- Easy installation on the handlebars for better integration.

Windshield Kit for Audio

All Ryker models

219401144



- Install a windshield on top of your audio system.
- Requires 219401033.

Smartphone Holder

All Ryker models

219400841



- RAM[®] Mount X-Grip system ensures secure smartphone attachment.
- Soft rubber endpoints protect device finish.
- Practical, convenient and engineered for travel on any road.
- Adapts to any phone size.
- Incompatible with the GPS Holder (219400796/219400940).

Cruise Control

Ryker 2022 and up

219401135



- Electronic Cruise Control.
- Ergonomic speed regulator integrated on the handlebars.
- Easy access.
- Easy installation.
- Minimum speed to activate the cruise control: 35 km/h.
- Minimum speed when activated: 30 km/h.

Glovebox Lock

Ryker 2021 and up

219401136



- Innovative Glovebox Lock.
- The latch is released when you wake up your vehicle (start button) and a valid key is detected.
- No need to start the engine or reverse throttle.
- The latch locks when the vehicle is turned off.
- If the D.E.S.S.[™] key is removed while the engine is running, the engine will continue to run and the latch will remain unlocked. So once the engine is off, the latch locks either when the key is removed or after a delay of about 30 seconds.
- Stock equipment on Ryker Sport and Ryker Rally models.

GPS Holder Kit	All Ryker models	219400796
-----------------------	------------------	------------------



- GPS Garmin[®] Zumo[®] 590 mount.
- Installs on the right handlebar via the RAM mount system and sits high for optimal visibility.
- Easily adjusts along both axes to minimize glare and reflected light.
- Incompatible with Smartphone Holder (219400841).
- Includes electrical harness.

GPS Holder Kit <i>(Not illustrated)</i>	All Ryker models	219400940
---	------------------	------------------

- GPS Garmin Zumo 590 mount.
- Installs on the right handlebar via the RAM mount system and sits high for optimal visibility.
- Easily adjusts along both axes to minimize glare and reflected light.
- Incompatible with Smartphone Holder (219400841).
- Does not include electrical harness.

Handguard Lighting	All Ryker models	219400820
---------------------------	------------------	------------------



- Customize your night rides with a uniquely personal touch.
- Adds distinctive flair and style to the Aluminum Hand guards.
- Requires Aluminum Hand guards (219400998) for installation.
- Not EC compliant.
- Not available in Europe.

LED Auxiliary Light	All Ryker models (except Ryker Rally 2022 and up)	219401075
----------------------------	--	------------------



- Delivers an extra 2,500 lumens of light.
- Enjoy a more visible night-riding experience.
- Fully integrated design blends in seamlessly with your vehicle.
- Incompatible with the Classic Hood Accent and Limited Edition Kit hood accent.
- Not EC compliant.
- Not available in Europe.

Auxiliary Lights	Spyder F3 2023 and prior	219400511
-------------------------	--------------------------	------------------



- Halogen fog lamps.
- Enhance low beam light for better visibility.
- Plug-and-play with stock harness.
- Integrated on/off switch.
- Not EC compliant.
- Not available in Europe.

Auxiliary Light	Spyder RT 2020 and up	219400991
------------------------	-----------------------	------------------



- Our LED Auxiliary Light helps redefine the night riding experience.
- Enhances confidence with improved low and wide visibility of the road ahead.
- Installs in minutes!
- Not EC compliant.
- Not available in Europe.

Signature Light	All Spyder models	<input type="checkbox"/> 219400895 • White
------------------------	-------------------	---



- Creates an unmistakable, distinctive look.
- No switch, automatically turns on.
- Includes required wiring and hardware for Spyder F3 2016 models and up.
- Not EC compliant.
- Not available in Europe.

Front Signature Light

Spyder RT 2020 and up

219401024



- First impressions count, so adding our Front Signature Light ensures that no matter whether you're coming or going, no one will forget you were there.
- Stock equipment on the Limited Edition model (except European models).
- Not EC compliant.
- Not available in Europe.

Driver Floorboards Signature Lights

Spyder RT 2020 and up

219401038



- Make your ride truly eye-catching with signature premium flair.
- Integrate effortlessly and seamlessly into the floorboards.
- Deliver an extra 1,600 lumens of bright white light.
- Enjoy a more visible night-riding experience.
- Not compliant with European regulations.
- Not available in Europe.

Passenger Floorboards Signature Lights

Spyder RT 2020 and up

219401153



- Make your ride truly eye-catching with signature premium flair.
- Integrate effortlessly and seamlessly into the floorboards.
- Enjoy a more visible night-riding experience.
- Not compliant with European regulations.
- Not available in Europe.

Power Outlet Kit

Spyder RT models
2019 and prior,
RS, ST, F3, F3-S

219400510 - USB

All Spyder RT models
2019 and prior,
all Spyder F3 models

219400366 - 12V



- Recharges your electronic devices while riding* (smartphone, MP3, heating gear, etc.).
- Dual port USB connectors.
- Plug-and-play kit.
- Simply connect under driver seat (F3) or in front cargo bin (RT) and use.
- The power outlet is not capable of recharging all device types while riding.
- Adds an extra 12V power outlet to your vehicle.

Driver Heated Grips

Spyder F3 2024 & up

219401286



- Five levels of intensity heating element for the handle bar grips.
- Easy installation.
- Integrated ON/OFF switch.

Heated Driver Grips

Ryker 2022 and up

219401115



- Heat levels for grips displayed on vehicle screen.
- Ergonomic button integrated on LH grip.
- Five temperature settings.
- Hold button to reach maximum heat quickly.
- Remembers your last heat setting.
- IP67-rated waterproof sealing keeps the elements out.
- ECE compliant.
- Plug-and-play installation.
- Clamp-on grips, no glue required.
- Compatible with cruise control.

RoadThunder SoundBar by MTX

F3-S 2023 and prior

219400840



- Bluetooth speaker with the unbeatable convenience of fingertip control.
- Rugged IP66-rated weather-resistant speaker designed for outdoor use.
- Driven by 150 watts of quality audio power.
- Seamless integration and operation from Bluetooth enabled devices.
- Includes: Input, ground and ignition wires, plus auxiliary port and 3.5" connector cable.

Note: We recommend you use 320 Kbps MP3 / 192-256 Kbps AAC / AIFF / WAV formats to match the potential of the speaker. More compressed formats will probably have degraded sound quality.

3.5 mm Audio Player Input

Spyder RT 2015 and prior, ST

710001406



- 3.5 mm cable for hooking up an MP3 player to top cargo's DIN connector.
- Driver volume control convenience through vehicle's cluster.

NEW LED Fog Lights

Canyon

219401192



- LED lights producing 800 lumens each.
- IP67 resistance rating.
- Legal according to European and North American regulations.
- Supplied with independent switch.
- Easy installation and compatible with vehicle harness.
- Automotive level quality lighting.
- Can be installed with or without the Adventure Front Bumper (219401193).
- Not EC compliant.
- Not available in Europe.

NEW Backup Camera Kit

Canyon, Spyder RT 2025 & up, Spyder F3-T, F3 LTD 2025 & up

219401199



- Fully waterproof rear view camera IP67.
- The camera is one of the clearest and sharpest available on the market with 538,000 pixel image resolution with 150° viewing angle.
- Features 4 infrared lights that allow up to 33 ft visibility in complete darkness.
- Stock equipment on Spyder F3 Limited Special Series, Spyder RT Sea-to-Sky and Canyon Redrock models.

NEW Heated Driver Grips

Canyon

219401222



- Standard grip replacement.
- Complete heating kit with 5 intensity settings.
- Heat levels for grips displayed on vehicle screen.
- Clamp-on grips, no glue required.
- Compatible with cruise control.

WHEELS AND FENDERS

Front Wheels

Ryker Rally

■ 219401146 • Deep Black



- Aluminum wheels.
- 15 spokes.
- Machined and tinted.
- Front wheels: 16 x 4.5 in. (406 x 114 mm).
- Sold in pairs.

Rear Wheel

Ryker Rally

■ 219401165 • Deep Black



- Aluminum wheel.
- 15 spokes.
- Machined and tinted.
- Rear wheel: 15 x 6.5 in. (381 x 165 mm).

Circuit Front Wheels

Ryker (except Rally models)

■ 219401159 • Liquid Gold



- Aluminum wheels.
- 16 spokes.
- Machined and tinted.
- Front wheels: 16 x 4.5 in. (406 x 114 mm).
- Sold in pairs.

Circuit Rear Wheel

Ryker (except Rally models)

■ 219401160 • Liquid Gold



- Aluminum wheel.
- 16 spokes.
- Machined and tinted.
- Rear wheel: 16 x 6.5 in. (406 x 165 mm).

SHOCKS

Occasional 2-Up Rear Shock

Spyder F3, F3-S

219400739



- Weight-bearing capacity designed for occasional 2-up use.

FOX⁺ Performance Series Rear Suspension

All Ryker models, except Rally Edition

219400799



- QS3 (Quick Switch) compression adjustment lets you custom-tune your ride for better comfort and handling.
- Works with the flip of a switch.
- Choose from precalibrated soft, medium, and firm settings according to driving conditions, passengers, and individual performance requirements.
- Features a spring preload adjustment.
- Black anodized 6061 aluminum alloy body with remote reservoir.
- Perfect for frequent 2-up or aggressive riding.

Swaybar

All Ryker models

219400819



- Helps reduce roll while heightening control and responsiveness while cornering.
- Enjoy a sportier, more confident ride.
- 33% stiffer than stock equivalent.

2-Up Rear Spring

(Not illustrated)

All Ryker models, except Sport and Rally models

219400974

- Stiffer rear springs.
- Recommended for occasional and frequent 2-up riding.
- Incompatible with the FOX Performance Series Rear Suspension (219400799).

SILENCERS

Akrapovič[†] Sinister Silencer

Spyder F3, F3-S

■ **219400701** • Black



- 3-outlet design exclusive to Can-Am.
- Finished in bold flat black carbon and stainless steel.
- Unique Akrapovič growl.
- Akrapovič Sinister Silencer Heat Shield Replacement Kit (219400766) available.
- Not AS certified.
- Certification EURO 3/EURO 4 (not EC certified for 2021 & up).

Akrapovič Exhaust

Spyder RT 2020 and up

■ **219401034** • US
■ **219401100** • Europe (not illustrated)



- Superior quality with premium titanium shell build, bold black carbon-fiber cap and heat shield.
- Ramped-up convenience with its three-outlet design.
- 55% lighter than a stock pipe, it really takes a load off.
- Get ready to rumble: the deeply resonant Akrapovič adds 133% sound output.
- Certification EURO 5 for 219401100.

Akrapovič Sport Touring 3C Silencer

Spyder RT 2015-2020
Spyder F3-T, F3 Limited,
F3 Special Series 2015
and up

■ **219400650** • US • Titanium
■ **219400838** • Europe • Titanium



- Set your ride apart with the dynamic, deep resonant sound of an Akrapovič silencer.
- Its premium titanium and carbon fiber construction is 55% lighter than the stock model and it's been tested to meet the most stringent requirements.
- Not AS certified.
- Certification EURO 3/EURO 4 for 219400838 (not EC certified for 2021 & up).

NEW Akrapovič Exhaust

Canyon

219401272 • US

219401273 • Europe



- Superior quality with premium titanium shell build, bold black carbon-fibre cap and heat shield.
- Ramped-up convenience with its three-outlet design.
- 55% lighter than a stock pipe, it really takes a load off.
- Get ready to rumble: the deeply resonant Akrapovič adds 133% sound output.
- Certification EURO 5 for 219401273.

CUSTOM ACCESSORIES

Rear Mud Flap

All Ryker models

219401137



- Additional protection for rear projections.
- Flexible material.

Rally Fender

All Ryker models

219400963



- Give your ride that distinctive look of adventure with the Rally Fender.
- Stock on Rally Edition model.

Mono Seat Cowl

All Ryker models

219401001



- Stylish Mono Seat Cowl transforms your ride into a sporty 1-up configuration while offering added protection to the tail section of our MAX Mount (219401169).
- Ultra-high-quality injection-molded scratch-resistant construction built for the road and made for mile after mile of solo adventure.
- Incompatible with Ryker LinQ Rack, Passenger Seat, Passenger Comfort Seat and LinQ Top Case.

Cluster Relocator

All Ryker models

219400948



- Moves the cluster forward, replacing the glove box, while its integrated spoiler lends it a clean, sporty look, all without impacting cluster visibility.
- Incompatible with Adjustable Sport Windshield, Gauge Spoiler and Front Storage Organizer.

Front Grille Trims

All Ryker models

■ **219400947** • Aluminum



- The Front Grille Trims are a great way to give the ultimate excitement ride that ultimate adventure look!
- Mounting on each side of the front grille, they're a stylish way to inject a performance look and feel that blends in perfectly with our other Rally accessories.

Super Sport Grille

All Spyder F3 models

■ **219400595** • Black / Can-Am Red



- Add an even more muscular look with this honeycomb-styled front grille with integrated front splitter.

Rear Spoiler

All Ryker models,
except Rally and Sport
models

■ 219400869 • Intense Black
■ 219400870 • Adrenaline Red
■ 219400871 • Yellow Shock



- Great-looking rear spoiler adds style to your vehicle.
- Easy to install.
- Incompatible with the MAX Mount (219401169) (2-up configuration).
- High-gloss finish.
- Matches Classic Panels.

Air Intake Accents with Pre-Filter

All Ryker models

219401025



- Make maintenance a snap with the easy-to-clean motor-side intake pre-filter.
- For heightened protection of your motor intake.
- Seamless integration with the Rally model with the two aesthetic air-intake clips.

Gauge Spoiler

All Ryker models

219400818



- Simple, effective aerodynamic tweak.
- Lends a sporty look that's easily customized with Gauge Spoiler Decals.
- Clips on without tools for quick, convenient installation.

Gauge Spoiler Decal

All Ryker models



- Easy-to-apply peel and stick customization for Gauge Spoiler (219400818).
- Enhances the appearance of your vehicle.

- **219400916** • Immortal White
- **219400917** • Adrenaline Red
- **219400918** • Army Green
- **219400936** • Haze Blue
- **219400937** • Orange Blaze
- **219400938** • Electric Yellow
- **219400980** • Pink Punk

Wheel Accents

Ryker models 2022 and prior except Sport and Rally Edition



- Easy-clip wheel accents for hassle-free customization.
- Add prominence and a fresh new look to your vehicle.
- Even more impressive when paired with Wheel Decals.
- Kit of 15 Wheel Accents.

- **219400825** • Intense Black
- **219400920** • Adrenaline Red

Wheel Decals

Ryker models 2022 and prior except Sport and Rally Edition



- The perfect road-ready eye candy designed to enhance the look of your ride.
- Easy-to-apply decals made for all your adventures.
- Pack a punch when combined with the Wheel Accents.
- Kit of 3 Wheel Decals.

- **219400921** • Adrenaline Red
- **219400922** • Army Green
- **219400933** • Haze Blue
- **219400934** • Orange Blaze
- **219400982** • Urban Camo
- **219401010** • Supersonic Green

Handlebar End Caps

Spyder 2023 and prior



- Sold in pairs.

- **219400702** • Chrome

Side Can-Am Trims

All Spyder RT models 2018 and prior



- Sold in pairs.

- **219400195** • Chrome



RIDE PROTECTION

Front Vehicle Protection

All Ryker models

219401108



- Additional protection for the front of your vehicle.
- Rally style.
- Incompatible with Radiator Protector.

Grille Protection Inserts

All Ryker models

219401161



- Small inserts to fully complement the front grille protection from small projections.
- Snap-in installation, no tools required.

Radiator Protector

All Ryker models

■ **219400999** • Aluminum



- Designed to deflect small rocks and other common road debris, it's your first line of defense against those small road hazards that can have a big effect on the look of your vehicle.

Splash Guards

All Ryker models

■ **219400817** • Black



- Simple and innovative design that works to protect against lower body splashing.

Skid Plate

All Ryker models

219401251

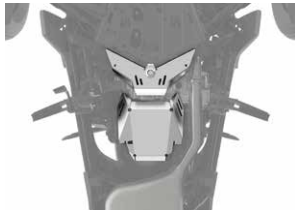

- Protects your ride with its sturdy two-piece stamped-aluminum construction.
- Keeps your CVT and YAW sensors safe from rock debris.

Locking Parking Brake Lever

All Ryker models

219401021



- One of the few accessories designed to stop your ride from moving, our safety-first Locking Parking Brake Lever means it stays put when parked to ensure your peace of mind.
- Stock equipment on all EUR Ryker models (2022 & up).

Fuel Tank Lock

Ryker 2021 and up

219401059



- Fuel Tank Cap with lock.
- 2 keys included.
- Stock equipment on all EUR Ryker models (2022 & up).

Fuel Tank Lock and Parking Brake Lock Kit

Ryker 2021 and up

219401147



- Lockable Fuel Tank Cap and Parking Brake Lock.
- Same key for both.
- 2 keys included.
- Stock equipment on all EUR Ryker models (2022 & up).

Ryker Learning Key

Ryker models equipped with the 900 ACE engine only

219401020



- Designed expressly for the Can-Am Ryker 900, the Learning Key is an excellent way for new drivers to get up to speed on our 3-wheel models.
- Top speed is limited to 56 mph (90 km/h) while still allowing for operation in Eco, Sport and Rally modes.

Knee Pads

All Ryker models

219400833



- Soft closed-cell polyurethane construction designed for enhanced knee comfort.
- Quick and convenient toolless installation.
- Provide additional grip.

NEW Headlight Protector

Canyon

219401171



- Easy installation within minutes.
- Hidden hardware installation for a clean and sleek look.
- Robust, impact-resistant polymer construction with steel grilles for improved protection.
- Headlamp protection is regulation compliant and is legal for road use.
- Easy cleaning.

NEW Adventure Front Bumper

Canyon

219401193



- Thick (5 mm) cast aluminium tube construction with black powder coat finish.
- Compatible with LED Fog Lights (219401192).
- Rugged look and perfectly contoured to match vehicle's line.

NEW Skid Plate

Canyon

219401220

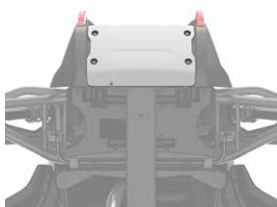

- Protects the front lower fascia of the vehicle.
- Made with 4 mm polypropylene.
- Does not affect oil changes.

NEW 10.25" Color Touchscreen Protector

Canyon

860202680



- Tempered glass - 0.3 mm thick.
- 9H hardness for tough protection.
- 100% bubble free adhesive.
- Anti-scratch, anti-glare and anti-fingerprint.
- Maintains 99.99% clarity.
- Easy to clean.
- Includes cleaning tools: wet wipe, dry wipe, dust absorber and soft cloth.

COVERS

F3 Limited Trailing Cover

F3-T (with optional top case), F3 Limited 2017 and up

■ 219400768 • Black



- Made of durable, 100% waterproof, fully breathable 300-denier polyester.
- Easy-on/easy-off system ensures cover is secure in all trailering conditions.
- Equipped with integrated exhaust panel and no-scratch flannel windshield liner.
- Compatible with all stock and accessory seats regardless of passenger or driver backrests, passenger armrests, windshield, or top case.

F3-T Trailing Cover

Spyder F3-T, F3 Limited 2016

■ 219400751 • Black



- Made of durable, 100% waterproof, fully breathable 300-denier polyester.
- Easy-on/easy-off system ensures cover is secure in all trailering conditions.
- Equipped with integrated exhaust panel and no-scratch flannel windshield liner.
- Compatible with all stock and accessory seats regardless of passenger or driver backrests, passenger armrests, or windshield.
- Incompatible with top case.

Outdoor Cover

Spyder F3-T, F3 Limited 2016

■ 219400603 • Black



- Durable solution-dyed UV and mildew-resistant 100-denier polyester construction.
- Soft inner liner protects windshields up to Tall Boy Windshield (219400596).
- Compatible with F3-T with or without passenger and driver backrests.
- Also compatible with all F3 windshields.
- Incompatible with Passenger Armrests (219400726).

Outdoor Cover

Spyder F3, F3-S

■ 219400495 • Black



- Durable solution-dyed UV and mildew-resistant 100-denier polyester construction.
- Inner liner protects windshield.
- Easy maintenance.

Travel Cover

Spyder F3-T, F3 Limited
2016

■ 219400604 • Black



- Start your morning ride with a dry, clean seat.
- Protects the top surfaces of your vehicle and stows compactly in the front compartment, making it a great road trip companion.

Custom Vehicle Cover

All Spyder RT models
2019 and prior

■ 219400860 • Black



- Made of tough water-repellent, breathable 300-denier polyester.
- This cover provides maximum vehicle protection while trailering or storing outdoors.
- Includes integrated exhaust panel and protective flannel windshield liner.
- Easy attach system secures cover in all trailering conditions.
- Compatible with RT Passenger Armrests (219400839).

RT Travel Cover

Spyder RT 2020 and up

■ 219400969



- Keep your favorite ride safe from the elements anywhere you stop while on the road.
- This 100-denier half-cover protects our optional Top Case (219401011) and comes complete with an integrated pocket for convenient storage when not in use.
- Accommodates all Can-Am accessories.

RT Outdoor Cover

Spyder RT 2020 and up

■ 219400968



- Protect the ride you love from the elements you want to avoid.
- This weatherproof, 100-denier cover is lined with no-scratch flannel for optimal windshield protection, so everything looks as good when the cover comes off as when it went on.
- Fits both the Standard and Limited edition models and accommodates all Can-Am accessories.

RT Trailering Cover

Spyder RT 2020 and up

■ 219400970



- Our 300-denier weatherproof Trailering Cover is the best way to keep things clean and dry.
- Complete with no-scratch flannel liner, convenient heat-resistant panel for exhaust protection, and all trailering attachments.
- Fits both the Standard and Limited edition models and accommodates all Can-Am accessories.

Outdoor Cover

All Ryker models

■ 219401141 • Black



- Rugged all-weather protection perfect for temporary vehicle storage.
- Ultra-durable solution-dyed, mildew-resistant 100-denier polyester construction.
- Easy to maintain.
- Equipped with anti-scratch lining.
- Amply sized to accommodate windshield and any accessory.

Indoor Cover

All Ryker models

■ **219401142** • Black



- Our fully extensible polyester Indoor Cover is the ideal solution to keep your vehicle clean until you're ready to hit the road and clock some miles.
- Accommodates all Can-Am accessories.
- Suitable for indoor use only.

Integrated Cover

All Ryker models

■ **219401143** • Black



- Keep your favorite ride safe from the elements anywhere you stop while on the road.
- This 100-denier half-cover protects our optional Top Case (219401011) and comes complete with an integrated pocket for convenient storage when not in use.
- Accommodates all Can-Am accessories!

NEW Travel Cover *(Not illustrated)*

Canyon

219401184

- Keep your favorite ride safe from the elements anywhere you stop while on the road.
- Made of durable, 100% waterproof, fully-breathable 100-denier polyester with PU coating.
- Compact size makes it convenient for traveling.
- Accommodates all Can-Am accessories.

NEW Outdoor Cover *(Not illustrated)*

Canyon

219401185

- Made of durable, 100% waterproof, fully-breathable 300-denier polyester with PU coating.
- Easy-on / easy-off system ensures cover is secure in all trailering conditions.
- Equipped with integrated exhaust panel and no-scratch flannel windshield liner.
- Accommodates all Can-Am accessories.



PARTS AND MAINTENANCE

PARTS AND MAINTENANCE

Genuine Can-Am Parts	76
XPS Engine Oils	77
XPS Maintenance Products	78

GENUINE CAN-AM PARTS

Air Filter	Ryker with 900 ACE engine, Spyder RS 2013 and up, Spyder RT with 998 cc engine 2010-2013, all Spyder ST models	707800306
	All Spyder/Canyon models with 1330 engine	707800483

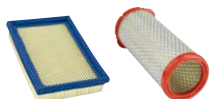

- Prevent airborne contaminants from reaching your engine.
- Protect internal components against premature wear.

Brake Pad Kits	All Ryker models	219800445 • Front Left 219800446 • Front Right 219800448 • Rear
	Spyder 2013 and up Canyon	219800237 • Front 219800239 • Rear



- Brembo® brake systems are considered to be the benchmark for quality and innovation, delivering the ultimate in performance, comfort, quiet, and durability in all road conditions.

NGK[†] Spark Plugs	Ryker 600 / 900	415130795 • CR8E
	All Spyder/Canyon models	415129670 • MR7BI-8



- NGK spark plugs are recommended by BRP and ensure your Can-Am vehicle's ROTAX engine runs smoothly and delivers optimum power at all times.
- Consistent, reliable performance make it an OEM favorite.

Oil Filter	Ryker 600 / 900	420956123
	Spyder SM6 & SE6 Canyon	420956744



- Original equipment oil filter, provides superior and reliable filtration levels.

Batteries	All Ryker models	219800540 • 12aH, 270 C.C.A.
	All Spyder models	219800519 • Yuasa YTX24HL. 21aH, 350 C.C.A.
	All Canyon models	715900973 • 20aH, 310 C.C.A.



- AGM technology.
- Factory activated.
- Maintenance free.

Yuasa 1.2 AMP Automatic Battery Charger & Maintainer	All models	529036620
---	------------	------------------



- Automatically switches to maintenance mode after battery reaches peak voltage.
- Designed to prevent overcharging.

Ryker External Snap Ring <i>(Not illustrated)</i>	All Ryker models	293370168
---	------------------	------------------

- Secures the center lock wheel nut.
- Mandatory in installation of the wheels.

Ryker Drive Belt	422280656 • 600 ACE engine
	417300571 • 900 ACE engine



- High-performance design ideal for on-road use.
- BRP-specific calibration adjusted to best suit your Can-Am vehicle.

Drive Belts

Spyder RT 2014 and up
All Canyon models.

705501304

All Spyder F3 models

705502157



- High-tensile strength carbon cord and HNBR rubber construction deliver impressive durability, superior flexibility and reduced noise, while resisting abrasion.
- Tooth-side fabric composed of special low-friction fiber.

Spare Drive Belt (Not illustrated)

Canyon and Spyder RT

705503903

- Temporary belt allowing access to the nearest service point.

Tires



XPS Rally

Ryker Rally

705403665 • Front • 145/60/R16

705503745 • Rear • 205/55R15

XPS Ride

Ryker/Ryker Sport

705403664 • Front • 145/60/R16

705503742 • Rear • 205/45R16

XPS Roadster

Spyder RT/ Spyder F3

706205067 • Front • 165/55R15

705503394 • Rear • 225/50R15

XPS Adventure

Canyon

706205036 • Front • 155/65R16

705503391 • Rear • 225/50/R15

- Designed to work in tandem with the Can-Am Spyder and Ryker innovative Vehicle Stability System to provide an ultra-stable, confident ride.

Mirrors

(Not illustrated)

Ryker

705018904 • Rear View Mirror

709403139 • Left Hand Side Mirror

709403140 • Right Hand Side Mirror

- Rear View Mirror
- Optional rear view mirror.
- Mounts on bar end.
- Includes mirror and hardware for installation.

- Left Hand Side Mirror/Right Hand Side Mirror
- Optional rear view mirror.
- Mounts on bar end.
- Includes mirror and hardware for installation.

XPS ENGINE OILS

9779492 • (US) - 946 ml / 1 quart

9779900 • (Europe) - 946 ml / 1 quart

XPS 4T 5W-40 Full Synthetic Oil

9779493 • (US) - 3.785 L / 1 US gallon

9779901 • (Europe) - 3.785 L / 1 US gallon



- Designed for high-performance off-road, on-road and PWC 4-stroke engines, including turbo or supercharged powersports engines.
- Powersport formula with premium anti-wear and anti-corrosion additives.
- Provides superior engine and transmission protection against rust and corrosion even in extreme conditions.

XPS 4T 5W-40 Synthetic Oil Change Kit



All Spyder models

9779482 • Rotax 991 (SM5) engine

9779483 • Rotax 991 (SE5) engine

9779484 • (US) - 1330 engine

9779958 • (Europe) 1330 engine

All Ryker models

9779490 • (US) - 600cc engine

9779956 • (Europe) - 600cc engine

9779491 • (US) - 900cc engine

9779957 • (Europe) - 900cc engine

- Ultra-convenient "all-in-one" oil change kit saves time and money.
- Includes XPS Synthetic Oil, oil filter, O-rings and washer.

XPS MAINTENANCE PRODUCTS

Synthetic Grease Suspension

9779163 • (US) - 14 oz. / 400 g
9779266 • (Europe) - 14 oz. / 400 g



- Designed to work specifically with the components found in Can-Am vehicle suspensions.
- It is highly stable and offers optimal lubrication at both extreme cold and high temperatures while protecting suspension components from dirt and moisture, as well as corrosion under extreme washout conditions.

DOT 4 Brake Fluid

9779151 • (US) - 12 fl. oz. / 355 ml
9779207 • (Europe) - 12 fl. oz. / 355 ml



- Meets or exceeds all DOT3 and DOT4 brake fluid requirements.
- High-temperature formula resists fade, and also conditions seals and O-rings in braking system.

Racing Brake Fluid RS600

9779152 • 12 fl. oz. / 355 ml



- Exceeds DOT4 brake fluid requirements for extreme conditions.
- Extreme, 579-degree boiling point temperature is ideal for high-demand conditions to combat brake fade.
- Will not harm seals or braking system components.
- Should be added only to a clean/unfilled system to avoid dilution and diminished performance.
- Low-moisture formula slows water vapor absorption through multiple heat cycles.

Extended Life Pre-mixed Coolant

9779150 • 946 ml / 1 quart



- Antifreeze/coolant contains the correct dilution and the necessary additives to prevent corrosion and inhibit cavitation in BRP cooling systems.
- Long-life, 5-year formula specially formulated for BRP vehicles.
- Superior heat transfer.
- Ideal replacement for vehicles that normally use a 2-year antifreeze/coolant (green).
- 5 years (orange).

Fuel Stabilizer

9779171 • (US) - 8 fl. oz. / 236 ml
9779183 • (Europe) - 8 fl. oz. / 236 ml



- Ethanol-compatible and will stabilize fuel in your tank to keep it from breaking down and causing hard starting, throttle hesitation and poor run quality.
- Ethanol attracts moisture, and this product contains powerful anti-corrosion additives to protect fuel system components.
- Prevents problems associated with E10 fuels.

Storage Oil

9779173 • 12 oz. / 350 g



- High-performance fogging oil designed to protect internal engine parts from rust and corrosion.
- This special formula exceeds other fogging oil performance.
- It coats engine internals indefinitely but is burned away through combustion when engine is started after storage.
- Protects engines during non-use or storage.
- Burns complete upon startup.

Anti-corrosive Lubricant

9779701 • 12 oz. / 340 g



- Multi-purpose lubricant that can also be used to prevent rust, corrosion and moisture intrusion.
- It contains extreme pressure additives that work as an all-around lubricant for just about anywhere lubrication is needed.



APPAREL

SIZING CHART

HOW TO MEASURE

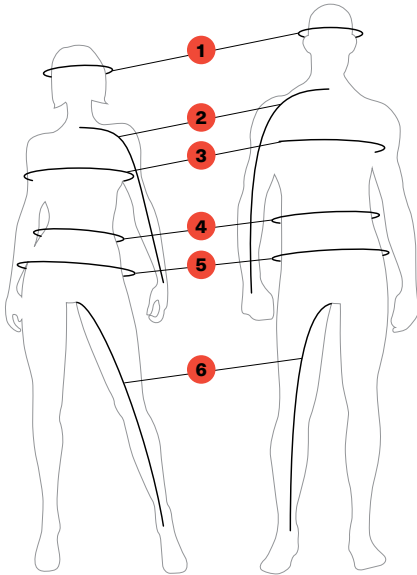

- For best results, have someone else take measurements.
- Measure body in underwear.
- Tape must be snug but not tight.
- If measurements fall between two sizes, order the larger size.

1 HEAD	Around your head, from the center of the forehead, above the ears and over the natural bump at the back of the head.
2 ARM LENGTH	Let the hands hang down on the side in a slightly bent position. Measure from the center of the back of your neck, along the length of your arm, to the wrist.
3 CHEST / BUST	Measure under your arms, around the fullest part of your chest.
4 WAIST	Measure around your natural waistline, keeping one finger between the tape and body.
5 HIPS	Across the widest part of the seat.
6 INSEAM	Without shoes, from crotch to the floor.

What code represents your style?

- 1 Find your size and color.
- 2 The corresponding code is THE CODE you use to complete the part number on your order.

Example:
 440975 (style number for the Men's Sythe Mesh Jacket CE/UKCA)
 06 (sizing code M)
 90 (color code Black)

Full SKU: **Style** | **Size** | **Color**
 440975 | 06 | 90

SIZING CODE

Adult		Adult		Adult		Adult		Adult		Pants		Youth/Kids	
Size	Code	Size	Code	Size	Code	Size	Code	Size	Code	Size	Code	Size	Code
One Size	00	XLT	13	X	26	5	24	13	33	30	37	3-4	79
XS	02	2XL	14	1X	86	6	25	14	34	32	38	5-6	52
S	04	2XLT	15	2X	87	7	27	16	35	34	39	6-8	48
M	06	3XL	16	3X	95	8	28	18	78	36	40	7-8	54
MT	07	3XLT	17	1	20	9	29	S/M	72	38	41	10-12	49
L	09	4XL	18	2	21	10	30	M/L	91	40	42	14-16	50
LT	10	4XLT	19	3	22	11	31	L/XL	73	42	43		
XL	12	5XL	88	4	23	12	32			44	44		

COLOR CODE

Name	Code	Name	Code	Name	Code	Name	Code
Clear	00	Lava Red	17	Violet	41	Indigo Blue	82
White	01	Mixed Color	18	Deep Purple	42	Royal Blue	83
Brown	04	Mirror Silver	22	Smoke	57	Navy	89
Charcoal Grey	07	Magnesium	24	Green	70	Black	90
Silver	08	Lilac	25	Teal	74	Black with Graphics	94
Grey	09	Hi-Vis Yellow	26	Turquoise (Aqua)	76	Amber	95
Yellow	10	Heather Charcoal	29	Army Green	77	Ivory	97
Gold	11	Red	30	Denim Blue	79		
Orange	12	Pink	36	Blue	80		
Coral	13	Ice	38	Light Blue	81		

APPAREL & SPORTSWEAR

MEN'S 170 - 182 CM

	XS	S	M	L	XL	2XL	3XL
Sizing Code	02	04	06	09	12	14	16
Chest	81-86	88-92	96-101	107-112	117-122	127-132	137-142
Waist	66-71	74-79	81-86	91-97	101-107	112-117	122-127
Hips (seat)	81-86	88-92	96-101	107-112	117-122	127-132	137-142
Arm length	76	79	81	84	86	89	89
Inseam	79	80	81	81	81	81	81

WOMEN'S 160-176 CM

	XS	S	M	L	XL	2XL	3XL
Sizing Code	02	04	06	09	12	14	16
Chest	83-88	88-92	94-99	101-107	112-117	122-127	132-142
Waist	69-74	74-79	79-84	86-91	96-101	107-112	117-127
Hips (seat)	91-97	96-101	101-107	109-114	112-124	122-135	140-150
Arm length	74	76	76	79	79	81	81
Inseam	76	76	76	76	76	76	76

Helmet sizing information is available on page 93.

Glove sizing information is available on page 102.



ADVEX HELMET WITH A SPORTY LOOK!



KEY BENEFITS



Great airflow



Fog free



ECE certified

USAGE

ACTIVE RIDERS

VARYING WEATHER

PRODUCT PERFORMANCE



Airflow



Lightweight



Field of view

ADVEX



ADVEX JET



TECHNOLOGIES



Retractable sun visor

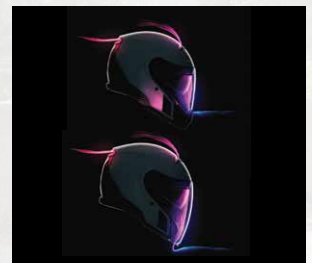

Airflow



Jet styling



Comm integration

HELMETS

UNISEX



Advex Jet Helmet (DOT/ECE)

929106 • DOT XS, S, M, L, XL, 2XL, 3XL	Black (90), Matte Black (93), White (01)
--	---

- ADVEX Jet Helmet (DOT/ECE) with M-FORGE Composite shell.
- 4-year limited warranty.
 - Lightweight M-FORGE® Composite shell.
 - Retractable sun visor.
 - Prescription eyeglasses friendly.
 - Adjustable humidity extractor vents.
 - Optional side LED utility light.
 - Optional VIBE Mesh integrated communication system.
 - 2 shell sizes and 4 EPS sizes for better fit and comfort.
 - Ratcheting quick-release chin strap.
 - Recyclable helmet shell for minimal environmental impact.
 - Aerodynamic shape to reduce neck fatigue.
 - 1535 g ± for size large.
 - DOT and ECE 2206 certified.



Advex Helmet (DOT/ECE)

929107 • DOT XS, S, M, L, XL, 2XL, 3XL	Black (90), Matte Black (93), White (01)
--	---

- ADVEX Helmet (DOT/ECE) with M-FORGE Composite shell.
- 4-year limited warranty.
 - Lightweight M-FORGE® Composite shell.
 - Visor with large field of view with Pinlock® Max Vision 120 anti-fog insert.
 - Retractable sun visor.
 - Prescription eyeglasses friendly.
 - Adjustable humidity extractor vents.
 - Optional side LED utility light.
 - Optional VIBE Mesh integrated communication system.
 - 2 shell sizes and 4 EPS sizes for better fit and comfort.
 - Ratcheting quick-release chin strap.
 - Recyclable helmet shell for minimal environmental impact.
 - Aerodynamic shape to reduce neck fatigue.
 - 1635 g ± for size large.
 - DOT and ECE 2206 certified.

HELMETS

MEN'S & WOMEN'S

	2XS	XS	S	M	L	XL	2XL	3XL
Sizing Code	01	02	04	06	09	12	14	16
Head (inches)	20 7/8-21 1/4	21 1/8-22	22 3/8-22 3/4	23 1/8-23 5/8	24-24 3/8	24 3/4-25 1/8	25 1/2-25 7/8	25 1/2-25 7/8
Head (cm)	53-54	55-56	57-58	59-60	61-62	63-64	65-66	65-66



THE VIBE JUST GETS BETTER

Now usable with most BRP helmets, the new upgraded version of the Vibe communication system keeps your fun rides rolling along.



The new Vibe Universal communication system delivers unparalleled connectivity and versatility when you ride. Fully BRP compatible with most helmets, this comm system might as well be an extension of the vehicle's ecosystem: use the 10.25" touchscreen display of your Can-Am vehicle to access unique functions to go above and beyond.



DID YOU KNOW ABOUT VIBE AND THE BRP GO! APP?

Ready, set, go! Set up and manage the Vibe universal communication system in no time directly in the free BRP GO! mobile app. You can check the battery level, change the device language, and much more!

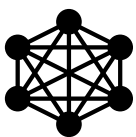

OPEN MESH INTERCOM: LIMITLESS



BLUETOOTH® 5.1

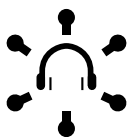

GROUP MESH INTERCOM: 20 RIDERS



INTERCOM 1.6 KM / 1 MI IN OPEN TERRAIN



MULTI-LANGUAGE VOICE COMMAND



ADVANCED NOISE CONTROL™

// ONE-CLICK-TO-CONNECT SIMPLICITY

// COMM INTEGRATION

// EASY INSTALL

// UP TO 15 HRS IN SUMMER CONDITIONS

OPEN MESH TECH (COMPATIBLE WITH SENA MESH SYSTEM)

COMMUNICATION SYSTEMS AND ACCESSORIES

MISC



NEW Vibe Universal Comm System by BRP

929105 • One size	Matte Black (93)	
-------------------	------------------	--

VIBE UNIVERSAL Comm System with superior audio quality for every BRP helmet.

- Sound by Harman Kardon®
- Mesh 2.0: Robust Reliability compatible with all Sena® Mesh devices.
- Largest battery capacity with 8 hours talk time at -18°C / -0°F
- One-Click-to-Connect simplicity.
- Mesh Intercom™ features superior audio quality.
- 1 antenna for up to 1.6 km in clear terrain (range can be affected by any external elements (topography, tree, snow, snow dust, electric cable, rain, etc.)).
- Multi-channel protocol in Open Mesh allows users to switch between 9 comm channels.

- Bluetooth® 5.1 enabled.
- Convenience of voice-activated digital assistant access ("Hey Google"/"Hey Siri").
- 30% faster Rapid-Charging.
- Glove-friendly interface.
- Compatible with all BRP helmets.
- Compatible with numerous new BRP snowmobile handle bar controls to mute/unmute, turn volume up or down and display information such as the battery status and mesh channel.

For safety reasons, the battery cannot be charged in riding conditions. Considering the increased risks inherent when charging a battery, BRP has chosen NOT to make this action possible to guarantee maximum user safety.

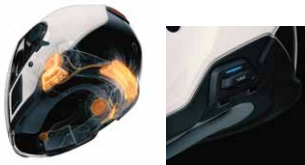

Vibe Communication System by BRP

929086 • One size	Matte Black (93)	
-------------------	------------------	--

VIBE Comm System with superior audio quality for the ADVEX helmet.

- Premium speakers and microphone with SOUND BY Harman Kardon®.
- Mesh 2.0: robust reliability compatible with all Sena Mesh devices.
- Largest battery capacity with 8 hours talk time at -18°C/0°F and up to 15 hours in summer conditions.
- One-Click-to-Connect simplicity.
- Mesh Intercom™ features superior audio quality.
- 2 antennas for 1.6 km line of sight range.

- Multi-channel protocol in Open Mesh allows users to switch between 9 comm channels.
- Bluetooth® 5.1 enabled.
- Convenience of voice-activated digital assistant access ("Hey Google"/"Hey Siri").
- 30% faster Rapid-Charging.
- Glove-friendly interface.
- Compatible with all ADVEX helmets.
- Compatible with your Can-Am handlebar control to mute/unmute, turn volume up or down and display information such as battery status.



BRP Helmet-Integrated LED Utility Light

929085	Matte Black (93)	
--------	------------------	--

- Optional utility light for Advex helmets family.
- Accessory for ADVEX Helmet.
- Utility flashlight.
- 3 power modes.
- 3 AAA batteries (battery box to install in the helmet, batteries not included).
- Uses the Vibe Communication System Battery.
- Connection of the Vibe Communication System by eLinQ (electric power supplied by the vehicle).
- Easy one-handed on/off without a button (by opening/closing).
- High level of illumination, over 100 lumens.
- ECE 22.06 certification for helmet.



RIDING JACKETS AND PANTS



CE UK
CA

Women's Metropolis Loki Riding Hoodie CE/UKCA

288034 • XS, S, M, L, XL, 2XL | Black (90)

Women's Full Zip Protective Riding Hoodie.
CLASS A Certified According to the EN 17092-4:2020 standard.
CE certified (EU safety, health and environmental protection requirements).
UKCA certified (UK Conformity Assessed marking).

- Main fabric: 86% nylon, 14% spandex.
- Inside fabric bonded with micro-fleece.
- PU Clear Lamination membrane.
- Water repellent.
- Wind repellent.
- Abrasion resistant fabric at elbow and shoulder.
- Included SAS-TEC removable Flex armor in elbow & shoulder (back armor sold separately).
- PU coated main zipper.
- Adjustable, snap-down hood that stays put while riding.
- Hand pockets with zipper closure.
- Adjustment at bottom hem with cord and cord lock.
- Inner cuff stretchable with thumb hole.
- Iridescent reflective details at elbow and at back.

KEY BENEFITS



Water-repellent



Reinforced material



Lifestyle look and feel



CE UK
CA

Men's Metropolis Loki Riding Hoodie CE/UKCA

454926 • S, M, L, XL, 2XL, 3XL | Black (90)

Men's Full Zip Protective Riding Hoodie.
CLASS A Certified According to the EN 17092-4:2020 standard.
CE certified (EU safety, health and environmental protection requirements).
UKCA certified (UK Conformity Assessed marking).

- Main fabric: 86% nylon, 14% spandex.
- TPU Clear Lamination membrane.
- Inside fabric bonded with micro-fleece.
- Water repellent.
- Wind repellent.
- Abrasion resistant fabric at elbow and shoulder.
- Included SAS-TEC removable Flex armor in elbow & shoulder (back armor sold separately).
- Armor position can be adjusted inside the armor pocket at elbow.
- PU coated main zipper.
- Adjustable, snap-down hood that stays put while riding.
- Hand pockets with PU coated zipper closure.
- Inside pocket with Velcro closure.
- Adjustment at bottom hem with cord and cord lock.
- Cuff tab adjustment.
- Black reflective details at elbow and at back.

KEY BENEFITS



Water-repellent



Reinforced material



Lifestyle look and feel



MEN'S



CE UK
CA

Men's Metropolis Aesir Commuter Pants CE/UKCA

441715 • 30, 32, 34, 36, 38, 40, 42, 44

Black (90)

Men's Commuter pants.
CLASS A Certified according to the EN 17092-4:2020 standard.
CE certified (EU safety, health and environmental protection requirements).
UKCA certified (UK Conformity Assessed marking).

- Main fabric: 87% nylon/ 13% elastane.
- Critical zones such as knees and hips have Kevlar® lining for abrasion resistance.
- Main fabric is stretchy and is composed of nylon fiber for superior abrasion resistance.

- Included SAS-TEC removable Flex armor in knees.
- Armor ready pockets at hips (sold separately).
- Armor knee position can be adjusted inside the armor pocket to ensure ample protection in riding position.
- Hand pocket with zipper closure.
- Venting pocket at back with mesh lining for optimal airflow.
- Back pocket with magnetic closure.
- Elastic panel with black reflective tape at back of leg opening.
- Reflective black heat transfer at back of knees.

KEY BENEFITS



Freedom of movement



Reinforced material



Lightweight

SIZING CODE

Pants

Size	Code	Size	Code	Size	Code	Size	Code
30	37	34	39	38	41	42	43
32	38	36	40	40	42	44	44

WOMEN'S



CE UK
CA

Women's Annick Jacket CE/UKCA

440966 • XS, S, M, L, XL

Charcoal Grey (07),
Warm Grey (15)

Women's soft textile jacket with leather inserts.
CE certified (EU safety, health and environmental protection requirements) A rating.
UKCA certified (UK Conformity Assessed marking).

- Main fabric: 88% nylon, 12% spandex.
- Quilted insert: 100% leather.

- Breathable and stretchable mesh panels at underarm and side panels.
- Removable SAS-TEC Flex armor in elbow and shoulder (back armor sold separately).
- Adjustable collar and cuffs.
- 2 exterior hand pockets.
- Café collar with snap closure.
- Pre-curved arms.

KEY BENEFITS



Great airflow



Stretch mobility



Reinforced



CE UK
CA

Women's Paso Moto Legging CE/UKCA

454716 • XS, S, M, L, XL

Black (90)

Women's Paso Moto Legging.

- CE certified - A rating (EU safety, health and environmental protection requirements).
- UKCA certified (UK Conformity Assessed marking).
- Ultra-stretch Kevlar knit at knees and sitting area.
- Removable SAS-TEC Flex armor in knees.
- Armor ready pockets at hips.
- Tonal reflective print.

JACKETS ARE MORE INCLUSIVE THAN EVER!

EXTENDED SIZING NOW AVAILABLE IN SELECT WOMEN'S STYLES

WOMEN'S ANNICK PLUS JACKET CE
440974

KEY BENEFITS



Women's-specific fit



Great airflow



Stretch mobility



Reinforced



We are dedicated to making riding inclusive for all women. We know it's not always easy finding the perfect fit, so we are thrilled to offer Plus Size ranges.

WHAT'S DIFFERENT?

- Different proportions.
- Increased stretch where it counts.
- Extended material for a more comfy ride.

SIZE REFERENCE

XS	S	M	L	XL	X	1X	2X	3X
2-4	6-8	10-12	14-16	16-18	18	20	22	24

RIDING GEAR

WOMEN'S



CE UK
CA

Women's Annick Jacket Plus CE/UKCA

440974 • X, 1X, 2X	Charcoal Grey (07), Warm Grey (15)	
---------------------------	---------------------------------------	--

Women's soft textile plus-sized jacket with leather inserts.

CE certified (EU safety, health and environmental protection requirements) A rating.

UKCA certified (UK Conformity Assessed marking).

- Main fabric: 88% nylon, 12% spandex.
- Quilted insert: 100% leather.

- Breathable and stretchable mesh panels at underarm and side panels.
- Removable SAS-TEC Flex armor in elbow and shoulder (back armor sold separately).
- Adjustable collar and cuffs.
- 2 exterior hand pockets.
- Café collar with snap closure.
- Pre-curved arms.



CE UK
CA

Women's Paso Plus Moto Legging CE/UKCA

441691 • X, 1X, 2X	Black (90)	
---------------------------	------------	--

Women's Paso Plus Moto Legging.

CE certified (EU safety, health and environmental protection requirements) A rating.

UKCA certified (UK Conformity Assessed marking).

- Ultra stretch Kevlar knit at knees and sitting area.
- Removable SAS-TEC Flex armor in knees.
- Armor ready pockets at hips.
- Tonal reflective print.



JACKETS

MEN'S



CE UK
CA

Men's Veda Chore Customizable Jacket CE/UKCA

440965 • S, M, L, XL, 2XL, 3XL	Charcoal Grey (07), Indigo Blue (82)
--------------------------------	--------------------------------------

Men's Veda Chore Customizable Jacket.

CE-certified (EU safety, health and environmental protection requirements) A rating.
UKCA-certified (UK Conformity Assessed marking).

- Main fabric: nylon 65%, cotton 35%.
- CORDURA® stretch twill.
- DWR treatment.
- Fully lined.

- Removable SAS-TEC Flex armor in elbow and shoulder (back armor sold separately).
- PU-coated zipper at front pocket and hand pockets.
- Storm flap over center front zipper with snaps.
- Internal water-resistant zip pocket.
- Customizable sleeve patch pad (for interchangeable patches with trim kit sold separately).
- Reflective details.

KEY BENEFITS



Max airflow



Stretch mobility



Lightweight



CE UK
CA

Men's Cuna Bomber Jacket CE/UKCA

440963 • S, M, L, XL, 2XL, 3XL	Army Green (77), Burgundy (35)
--------------------------------	--------------------------------

Men's Cuna Bomber Jacket.

CE-certified (EU safety, health and environmental protection requirements) A rating.

UKCA-certified (UK Conformity Assessed marking).

- Main fabric: 90% PES (polyethersulfone), 7% PU, 3% elastane.
- DWR treatment.
- Insulation: 40 gsm compact polyfill.
- CORDURA® nylon at sleeves and hand pockets for weather-resistant storage.

- Removable SAS-TEC Flex armor in elbow and shoulder (back armor sold separately).
- Center front PU-coated zipper.
- Internal water-resistant zip pocket.
- 2 exterior hand pockets.
- Rib at cuff, waistband and collar.
- Branding at chest as sunglasses loop.
- Reflective details.

KEY BENEFITS



Insulated



Reflective



Water resistant

MEN'S



CE UK
CA

Men's Rone Harrington Jacket CE/UKCA

440972 • S, M, L, XL, 2XL, 3XL	Charcoal Grey (07), Indigo Blue (82)	
---------------------------------------	---	--

Men's Rone Harrington Jacket.

CE-certified (EU safety, health and environmental protection requirements) A rating.

UKCA-certified (UK Conformity Assessed marking).

- Main fabric: 95% PES (polyethersulfone), 5% PU.
- CORDURA® stretch nylon.
- 40 gsm compact polyfill.
- Inner liner in square quilt with performance wicking material.
- DWR treatment.
- Removable SAS-TEC Flex armor in elbow and shoulder (back armor sold separately).
- PU-coated zipper at center front and 2 hand pockets.
- No-pro pocket at chest to enable hands-free pictures.
- Internal water-resistant zip pocket.
- Rib at cuffs and bottom hem.
- Sunglasses loop at chest.
- Reflective details.

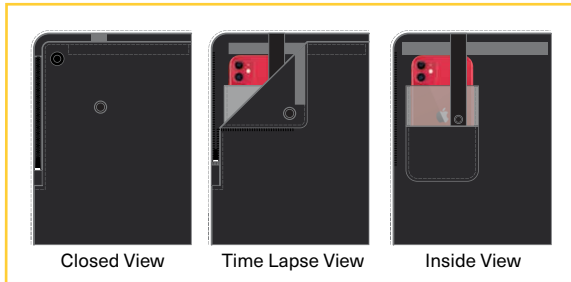

INTEGRATED TIMELAPSE PHONE POCKET

No action camera needed. Simply secure your phone, snap it into place, set it to time lapse and go!

KEY BENEFITS



Insulated



Reflective



Durable

WOMEN'S



CE UK
CA

Women's Lipa Customizable Jacket CE/UKCA

440967 • XS, S, M, L, XL	Charcoal Grey (07), Indigo Blue (82)	
---------------------------------	---	--

Women's customizable tour jacket.

CE-certified (EU safety, health and environmental protection requirements) A rating.

UKCA-certified (UK Conformity Assessed marking).

- Main fabric: nylon 65%, cotton 35%.
- CORDURA® stretch twill.
- Fully lined.
- DWR treatment.
- Removable SAS-TEC Flex armor in elbow and shoulder (back armor sold separately).

- PU-coated zipper at front pocket and hand pockets.
- Storm flap over center front zipper with snap.
- Internal water-resistant zip pocket.
- Snap cuffs closure.
- Customizable sleeve patch pad (for interchangeable patches with trim kit sold separately).
- Reflective details.

KEY BENEFITS



Max airflow



Stretch mobility



Lightweight



CE UK
CA

Women's Lipa Plus Customizable Jacket CE/UKCA

440971 • X, 1X, 2X	Charcoal Grey (07), Indigo Blue (82)	
---------------------------	---	--

Women's touring customizable plus-sized jacket.

CE certified (EU safety, health and environmental protection requirements) A rating.

UKCA certified (UK Conformity Assessed marking).

- Main fabric: nylon 65%, cotton 35%.
- CORDURA® stretch twill.
- Fully lined.
- DWR treatment.

- Removable SAS-TEC Flex armor in elbow and shoulder (back armor sold separately).
- PU coated zipper at front pocket and hand pockets.
- Storm flap over center front zipper with snap.
- Internal water-resistant zip pocket.
- Snap cuffs closure.
- Customizable sleeve patch pad (for interchangeable patches with trim kit sold separately).
- Reflective details.

CE AND SAS-TEC

CE CERTIFICATIONS

Let's face it, getting riding gear and equipment that will protect you on the road can be complex. With a wide variety of different laws, certifications, and rating systems, it can all become very confusing very fast.

However, you can ride assured when you see the CE symbol on your Can-Am gear. These products have gone through significant testing and meet the stringent requirements necessary to earn this certification.

All of our CE certified items have passed the following tests: impact abrasion resistance, tear strength, seam strength, wash testing, and chemical testing.

So when you see the CE mark on your Can-Am gear, you can ride with peace of mind knowing your equipment has you covered.



SAS-TEC PROTECTORS

Our riding jackets include removable SAS-TEC protectors in the shoulders and elbows, as well as a zone for a back protector (sold separately). SAS-TEC protectors are low-profile, modular, and most importantly, highly effective shock absorbers.

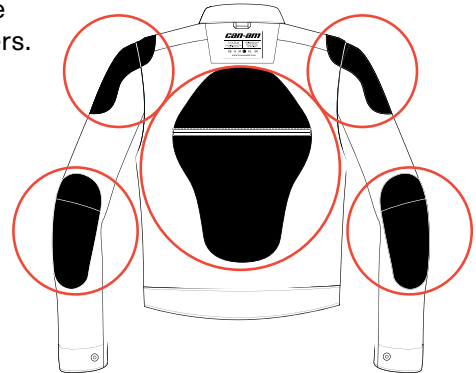

UNISEX



NEW Removable Hip Protectors (Pair)

488102 • One size	Black (90)	
-------------------	------------	--

Removable Hip Protectors (pair). We recommend these protectors for the hip area.

- CE Level 1.
- Flexible and lightweight.

- Almost invisible under clothing.
- Removable, hand washable and usable after impact.
- Sold as a pair.

- **Fit:**
- Pant hips for men and women.



NEW Removable Back Protector (Unit)

488098 • L	Black (90)	
------------	------------	--

Removable Back Protector (unit). Central back protector.

- CE level 1.
- Almost invisible under clothing.

- Removable, hand washable and usable after impact.
- Sold per unit.

- **Fit:**
- All jackets for men and women.

WOMEN'S



NEW Removable KCAAir Protectors (pair)

456047 • One size	Black (90)	
-------------------	------------	--

SC-1 / KCAAir velcro.

We recommend these protectors for elbows, shoulders or knees.

- CE Level 1.
- Flexible and lightweight.
- Almost invisible under clothing.
- Removable, hand washable and usable after impact.
- Sold as a pair.

UNISEX



NEW Removable KCAAir Velcro Protectors (pair)

456073 • One size	Black (90)	
-------------------	------------	--

SC-1 / KCAAir Velcro.

We recommend these protectors for use in shoulders, elbows and knees.

- CE Level 1.
- Flexible and lightweight.
- Almost invisible under clothing.
- Removable, hand washable and usable after impact.
- Sold as a pair.

GLOVES

	UNISEX PEERCE RADIANT LEATHER	MEN'S METROPOLIS LEATHER GLOVES	WOMEN'S LEATHER GLOVES	UNISEX STEER 2.0 GLOVES
Ventilation	●●○○○	●●●○○	●●●○○	●●●●○
Armor	●●●●●	●●●●○	●●●○○	●●○○○
Price	●●●●●	●●●○○	●●○○○	●○○○○
Sizes	XS TO 3XL	XS TO 3XL	XS TO XL	XS TO 3XL

MEN'S



CE UK
CA CA

NEW Men's Metropolis Leather Gloves

288071 • XS, S, M, L, XL, 2XL, 3XL	Black (90)	
------------------------------------	------------	--

Introducing our Men's leather Can Am Onroad glove crafted for both style and safety. Made from premium goat leather, these gloves offer a comfortable fit while providing essential protection for your hands on the road.

- Top grain goatskin leather.
- Hard-shell TPR knuckle; CE LEVEL 1 + KNUCKLE.
- Adjustment tab cuff.
- Stretch lips at fingers and upper hand for better dexterity.
- Tricot mesh liner.
- Perforated leather for breathability.

WOMEN'S



CE UK
CA CA

NEW Women's Leather Gloves

288044 • XS, S, M, L, XL	Black (90), Warm Grey (15)	
--------------------------	-------------------------------	--

Introducing our Women's leather Can-Am Onroad glove crafted for both style and safety. Made from premium goat leather, these gloves offer a comfortable fit while providing essential protection for your hands on the road.

Features and technologies:

- Top grain goatskin leather.
- CE Level 1 protection.
- Index and thumb touchscreen.
- Padded knuckles, palm and thumb.
- Stretch panels at knuckles.
- Ultra short wrist cuff.
- Unlined fingers for dexterity and grip.
- Perforated holes on fingers and fourchettes.

UNISEX



Unisex Peerce Radiant Leather Gloves CE/UKCA

446349 • XS, S, M, L, XL, 2XL, 3XL	Black (90)	
------------------------------------	------------	--

Peerce Radiant Leather Gloves using clim8® heated technology. CE-certified (EU safety, health and environmental protection requirements) A rating. UKCA-certified (UK Conformity Assessed marking).

- 90% leather, 5% PES (polyethersulfone), 3% neoprene, 2% ELS.
- Main: matte finish, goatskin leather.
- Liner: fleece with antimicrobial.
- Insulation: 100 gsm at back of hand.
- Gauntlet gusset in 4-way stretch CORDURA®.
- Palm slider protector.

- Fully lined with anti-microbial brushed fleece.
- Back hand insulation 100 gms.
- Elastic wrist with hook and loop tab closure.
- Accordion rib detail throughout.
- 3 mm neoprene panel integrated under floating knuckle.
- Touchscreen index and thumb.
- Long gauntlet with adjustable hook and loop tab.
- Reflective details.
- D30 integrated knuckle.
- Includes 2 batteries and a charger.



Unisex Can-Am Steer 2.0 Gloves CE/UKCA

446373 • XS, S, M, L, XL, 2XL, 3XL	Black (90), Green (70)	
------------------------------------	------------------------	--

Textile air mesh Ranger Gloves. CE-certified (EU safety, health and environmental protection requirements) A rating. UKCA-certified (UK Conformity Assessed marking).

- 55% PES (polyethersulfone), 28% leather, 10% airprene, 5% ELS, 2% PU.
- 4-way air mesh.

- Perforated synthetic leather palm.
- Leather reinforcing panels on the palm.
- Articulated fingers for easier movements.
- Hard knuckle protector.
- Touchscreen index and thumb.
- Hook and loop wrist closure.
- Reflective details.



Battery (1-PCE) for Heated Gear

488100 • Onesize	Black (90)	
------------------	------------	--

- 1x Lithium ion battery, 7.4 V, 3,000 mA.
- Rechargeable.



Battery Charger for Heated Gear

488101 • Onesize	Black (90)	
------------------	------------	--

- Battery Charger with dual output.
- EU/US interchangeable plugs.



GLOVES (measure palm width)

UNISEX	XS	S	M	L	XL	2XL	3XL
Sizing Code	02	04	06	09	12	14	16
Palm (inches)	3	3¼	3½	4	4½	5	5½
Palm (cm)	7½	8	9½	10	11½	13	14

GLOVES

UNISEX



CE UK
CA

Unisex Ranger Gloves CE/UKCA

446355 • XS, S, M, L, XL, 2XL, 3XL	Black (90)	
---	------------	--

Textile air mesh Ranger Gloves. CE-certified (EU safety, health and environmental protection requirements) A rating. UKCA-certified (UK Conformity Assessed marking).

- 55% PES (polyethersulfone), 28% leather, 10% airprene, 5% ELS, 2% PU.
- 4-way air mesh.

- Perforated synthetic leather palm.
- Leather reinforcing panels on the palm.
- Articulated fingers for easier movements.
- Hard knuckle protector.
- Touchscreen index and thumb.
- Hook and loop wrist closure.
- Reflective details.



CE UK
CA

Unisex Peerce Leather Gloves CE/UKCA

446347 • XS, S, M, L, XL, 2XL, 3XL	Black (90)	
---	------------	--

Peerce Leather Gloves. CE-certified (EU safety, health and environmental protection requirements) A rating. UKCA-certified (UK Conformity Assessed marking).

- 90% leather, 5% PES (polyethersulfone), 3% neoprene, 2% ELS.
- Main: matte finish, goatskin leather.
- Liner: antimicrobial fleece.

- Insulation: 100 gsm at back of hand.
- Gauntlet gusset in 4-way stretch CORDURA® with adjustable hook and loop tab.
- Palm slider protector.
- 3 mm neoprene panel integrated under the floating knuckle.
- Touchscreen index and thumb.
- Reflective details.

NECKWEAR

UNISEX



Unisex Riding Tube Can-Am

454746 • One size	Charcoal Grey (07), Black (90)	
--------------------------	--------------------------------	--

Multi-purpose, stretchy and comfortable tubular headwear. Can be worn to cover the neck, neck and face, top of head, and many other ways.

- Protects from sun, wind, or cold.
- Quick dry.
- Keeps hair out of face.
- Flat locked seams to avoid skin chafing.

RAIN GEAR

UNISEX



Unisex Seil Packable Jacket

440968 • XS, S, M, L, XL, 2XL, 3XL

Green (70)

Unisex Seil Packable Jacket. Can be easily stored away when the rain stops.

Made to be paired up with Unisex Aegis Rain Overpant.

- Main fabric: 85% PES (Polyethersulfone), 10% TPU, 5% elastane.
- Completely seam-sealed.

- Hidden hand pockets with water-resistant zippers.
- Welded waterproof chest pockets.
- Packable in back pocket.
- Lycra cuff with thumbholes.
- Adjustable cuffs.
- Reflective details.



Can-Am Unisex Emergency Rain Kit

440979 • XS, S, M, L, XL, 2XL, 3XL

Black (90)

Can-Am Unisex Emergency Rain Kit. Two piece rain suit.

- 100% PES (polyethersulfone).
- Waterproof zipper.
- Adjustment possible at neck to avoid water entry.

- High elasticated waist.
- Zipper at leg for easy on/off.
- Storage bag for jacket and pant.
- Can-Am reflective print on chest and arm.



Unisex Aegis Rain Overpants

441687 • XS, S, M, L, XL, 2XL, 3XL

Black (90)

Unisex Aegis Rain Overpants. Easily foldable.

Made to be paired up with Unisex Seil Packable Jacket.

- 85% PES (polyethersulfone), 10% TPU, 5% elastane.
- Fully seam-sealed.
- Packable in back pocket.

- Hidden hand pockets with water-resistant zippers.
- Welded waterproof chest pockets.
- Packable in back pocket.
- Lycra cuff with thumbholes.
- Adjustable cuffs.
- Reflective details.



SPORTSWEAR

MEN'S



Men's Performance Long Sleeves

288064 • S, M, L, XL, 2XL, 3XL | Black (90), Indigo Blue (82)

Performance Long Sleeve T-Shirt.

- Moisture-wicking.
- UPF protection 40.
- Small Can-Am print on chest and large Can-Am artwork at back.



NEW Men's Can-Am Signature Pullover Hoodie

288047 • S, M, L, XL, 2XL, 3XL | Black (90)

Comfortable Pullover Hoodie sweatshirt with Can-Am logo at the front.

- 60% cotton, 40% polyester.
- Relaxed fit.
- Rib at cuffs and hem.
- Kangaroo pocket.
- Can-Am logo at center front and small artwork at sleeve.
- Can-Am label at front kangaroo pocket.



Men's Can-Am Signature Crewneck Sweatshirt

288068 • S, M, L, XL, 2XL, 3XL | Black (90)

Comfortable crewneck sweatshirt with Can-Am logo on the front.

- 60% cotton, 40% polyester.
- Relaxed fit.
- Rib at cuffs and hem.
- Can-Am logo at center front and small artwork at sleeve.



Performance Long Sleeve T-Shirt

454694 • S, M, L, XL, 2XL, 3XL | Charcoal Grey (07), Red (30)

Performance Long Sleeve T-Shirt.

- Print on front chest.
- Moisture-wicking.
- UPF protection 40.



NEW Men's Can-Am DNA Long Sleeve T-Shirt

288118 • S, M, L, XL, 2XL, 3XL | Black (90)

Graphic long sleeve T-Shirt with crewneck.

- Heather colors: 50% cotton, 50% polyester.
- Solid colors: 100% cotton.
- Small Can-Am logo at front and large Can-Am artwork at back.



Men's Wolves Long Sleeves T-Shirt

454943 • S, M, L, XL, 2XL, 3XL | Black (90), Charcoal Grey (07)

Men's graphic long sleeve T-shirt.

- 50% polyester, 50% cotton.
- Small Can-Am logo at center front and large Can-Am artwork at back.
- Artwork details also on sleeve.

WOMEN'S



Women's Signature Pullover Hoodie

288249 • XS, S, M, L, XL	Black (90)	
--------------------------	------------	--

Ladies' Pullover Ponte Hoodie.

- 380 gsm.
- Side zippers opening. Tone-on-tone print at back.
- Kangaroo pocket.
- Jersey cuff with thumb hole.



Women's Can-Am Signature Crewneck Sweatshirt

288250 • XS, S, M, L, XL	Black (90)	
--------------------------	------------	--

Ladies' Pullover Ponte Hoodie.

- 380 gsm.
- Side zippers opening. Tone-on-tone print at back.
- Kangaroo pocket.
- Jersey cuff with thumb hole.

MEN'S



NEW Men's Can-Am Cruiser T-Shirt

288049 • S, M, L, XL, 2XL, 3XL	Army Green (77), Black (90)	
--------------------------------	-----------------------------	--

- Graphic T-shirt with crewneck.
- Heather colors: 50% cotton, 50% polyester.
- Solid colors: 100% cotton.
- Can-Am logo with vehicle artwork in the back.
- Vehicle artwork at left chest.



Men's All Ride T-Shirt

454946 • S, M, L, XL, 2XL, 3XL	Black (90), Charcoal Grey (07)	
--------------------------------	--------------------------------	--

Men's graphic T-shirt.

- 50% polyester, 50% cotton.
- Small Can-Am print on chest and large Can-Am artwork at back.



NEW Men's Racing T-Shirt

288024 • S, M, L, XL, 2XL, 3XL	Navy (89), White (01)	
--------------------------------	-----------------------	--

Relaxed T-shirt with crewneck.

- Heather colors: 50% cotton, 50% polyester.
- Solid colors: 100% cotton.
- Racing logo all over.
- Can-Am label at bottom hem.

MEN'S



NEW Men's Can-Am Signature T-Shirt

288115 • S, M, L, XL, 2XL, 3XL	Army Green (77), Black (90), Heather Grey (27), Wine (32)
---------------------------------------	--

Signature T-shirt with crewneck for everyday wear.

- Heather colors: 50% cotton, 50% polyester.
- Solid colors: 100% cotton.
- Rib collar.
- Can-Am logo at center front chest.



NEW Men's Can-Am DNA T-Shirt

288116 • S, M, L, XL, 2XL, 3XL	Black (90), Navy (89)
---------------------------------------	-----------------------

Graphic T-shirt with crewneck.

- Heather colors: 50% cotton, 50% polyester.
- Solid colors: 100% cotton.
- Can-Am logo with artwork at back.
- Can-Am artwork at left chest



NEW Men's Signature Long Sleeve T-Shirt

288117 • S, M, L, XL, 2XL, 3XL	Army Green (77), Black (90)
---------------------------------------	-----------------------------

Signature long sleeve T-shirt for everyday wear.

- Heather colors: 50% cotton, 50% polyester.
- Solid colors: 100% cotton.
- Can-Am logo at left chest and on the right sleeve.



NEW Men's Roadway T-Shirt

288121 • S, M, L, XL, 2XL, 3XL	Army Green (77), Wine (32)
---------------------------------------	----------------------------

Graphic T-shirt for everyday wear.

- Heather colors: 50% cotton, 50% polyester.
- Solid colors: 100% cotton.
- Large Can-Am artwork at back and small artwork at left chest.

WOMEN'S



Women's Graphic WMN T-Shirt

454955 • XS, S, M, L, XL, 2XL, 3XL	Black (90), Heather Charcoal (29)
---	--------------------------------------

Women's graphic T-shirt.

- 50% polyester, 50% cotton.
- Small WMN print on chest and large WMN artwork at back.



Women's Performance Long Sleeves

288021 • XS, S, M, L, XL, 2XL	Black (90), Purple (40)
--------------------------------------	-------------------------

Women's performance long sleeves T-shirt.

- Moisture-wicking.
- UPF protection 40.
- Mesh panel at chest and back for breathability.
- Can-Am print on right sleeve.

WOMEN'S



NEW Women's Can-Am Rally Boxy T-Shirt

288026 • XS, S, M, L, XL, 2XL, 3XL

Black (90), Heather Grey (27)

Women's graphic T-shirt with crewneck and boxy fit.

Features:

- Heather colors: 50% cotton, 50% polyester.
- Solid colors: 100% cotton.
- Boxy fit.
- Can-Am logo with vehicle artwork in the back.
- Vehicle artwork at left chest.



NEW Women's Can-Am Signature T-Shirt

288119 • XS, S, M, L, XL, 2XL, 3XL

Black (90), Heather Grey (27), Navy (89)

Women's signature T-shirt with crewneck.

Features:

- Heather colors: 50% cotton, 50% polyester.
- Solid colors: 100% cotton.
- Regular fit.
- Small Can-Am logo at center front chest.



NEW Women's Racing Boxy T-Shirt

288120 • XS, S, M, L, XL, 2XL, 3XL

Black (90), Heather Grey (27)

Women's graphic T-shirt with crewneck and boxy fit.

Features:

- Heather colors: 50% cotton, 50% polyester.
- Solid colors: 100% cotton.
- Boxy fit.
- Racing logo all over.
- Can-Am label at bottom hem.



CAPS AND NECKWEAR

UNISEX



Infinite Motion Can-Am Curved Cap

454959 • One size	Charcoal Grey (07), Indigo Blue (82), Black (90)	
--------------------------	--	--

Curved cap with woven label.

- Can-Am artwork on front woven label.
- Snapback closure at back with small Can-Am label.



Wolves Among Sheep Flat Cap

454961 • One size	Black (90)	
--------------------------	------------	--

Flat cap with screen printed Can-Am artwork at front.

- Snapback closure at back with small Can-Am label.



NEW Unisex Can-Am Racing Adjustable Cap

288080 • One size	Black (90), Navy (89)	
--------------------------	-----------------------	--

Can-Am Racing cap.

- 100% cotton.
- Can-Am logo on the front.
- Racing inspiration.
- Snapback closure at back with small Can-Am label.



NEW Unisex Can-Am Flex Fit Signature Cap

288112 • One size	Army Green (77), Black (90), Grey (09), Wine (32)	
--------------------------	---	--

Signature curved cap.

- 100% cotton.
- Embroidery Can-Am patch at front.
- Snapback closure at back with small Can-Am label.



NEW Unisex Can-Am Flat Cap

288113 • One size	Black (90), Sand (03)	
--------------------------	-----------------------	--

Flat cap with screen printed Can-Am artwork at front.

- Snapback closure at back with small Can-Am label.



NEW Unisex Can-Am DNA Flat Cap

288114 • One size	Black (90), Grey (09)	
--------------------------	-----------------------	--

Flat cap with screen printed Can-Am DNA artwork at front.

- Snapback closure at back with small Can-Am label.



Unisex Neck Gaiter

447841 • One size	Black (90)	
--------------------------	------------	--

Neck gaiter with spandex material for a better fit.

- 100% polyester.
- Anti-pilling fleece.

BAGS AND ACCESSORIES

UNISEX



Can-Am Laptop Backpack

469318 • One size	Charcoal Grey (07)	
-------------------	--------------------	--

Can-Am Laptop Backpack.

- Laptop/tablet pocket holds up to a 15" laptop.
- Rain cover.
- Fleece-lined sunglasses pocket.
- Adjustable shoulder and chest straps.
- Organization pocket with key clip.
- Foam padding on straps and back for comfort.
- Carry-on slider.
- Water bottle side pouch.
- 900D polyester.
- 25 L.
- 30 cm x 45 cm x 21 cm.





BRP REIMAGINES THE WAY YOU ACCESS YOUR WORLD

Can-Am is one of many success stories from BRP, the global company behind some of the most daringly innovative products and experiences that move you. Because it's not about the destination, it's about the journey — yours.

Discover our brands:

ski-doo **LYNX** **SEA-DOO** **can-am** **ROTAX** **ALUMACraft** **MANITOU** **QUINTREX**

www.brp.com

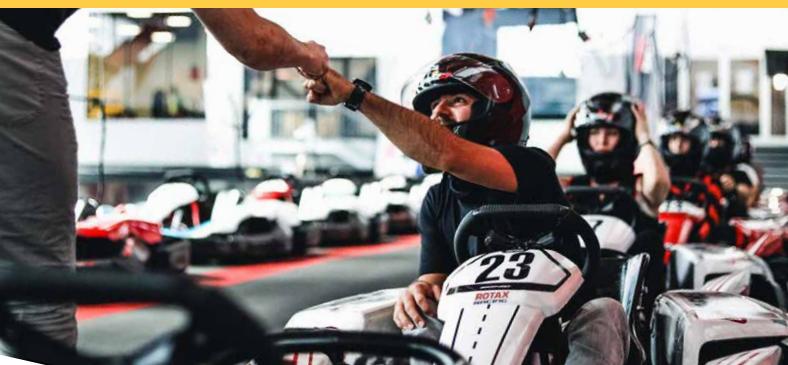



CANAMONROAD.COM

